



# OPERATOR'S MANUAL

## HWH COMPUTER-CONTROLLED LEVELING SYSTEM

### 680 SERIES

## SPACEMAKER ROOM EXTENSION SYSTEM

### FEATURING:

***TOUCH PANEL LEVELING CONTROL***

***AIR LEVELING***

***DUAL CYLINDER "LEVEL FLOOR" ROOM EXTENSION***

***SINGLE CYLINDER "BEDROOM" ROOM EXTENSION***

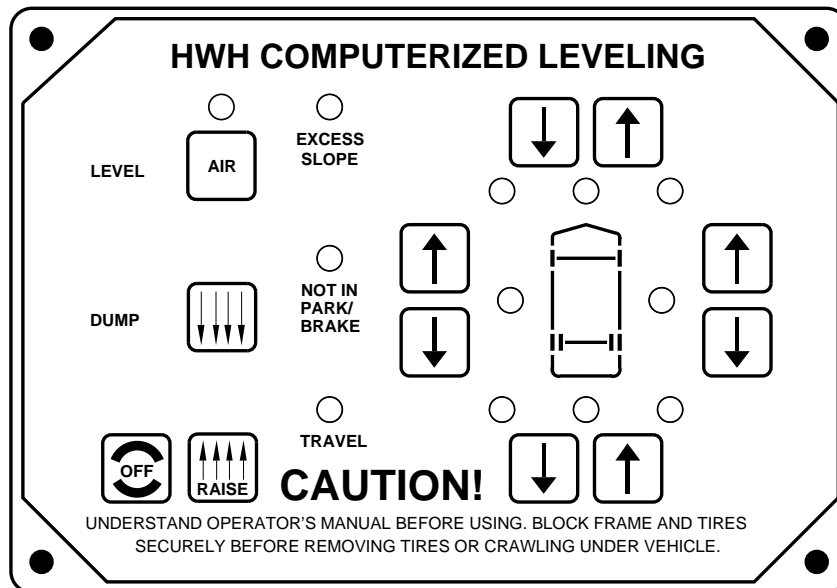

**HWH CORPORATION**

**(ON I-80, EXIT 267 SOUTH)**

**2096 MOSCOW ROAD**

**MOSCOW, IOWA 52760**

**(800) 321-3494 / (563) 724-3396**

**INTERNET: <http://www.hwhcorp.com>**

---

# OPERATOR'S MANUAL

---

## CAUTION !

READ THE ENTIRE OPERATOR'S MANUAL BEFORE OPERATING.

BLOCK FRAME AND TIRES SECURELY BEFORE CRAWLING UNDER VEHICLE. DO NOT USE LEVELING JACKS OR AIR SUSPENSION TO SUPPORT VEHICLE WHILE UNDER VEHICLE OR CHANGING TIRES. VEHICLE MAY DROP AND/OR MOVE FORWARD OR BACKWARD WITHOUT WARNING CAUSING INJURY OR DEATH.

KEEP ALL PEOPLE CLEAR OF VEHICLE WHILE LEVELING SYSTEM AND ROOM EXTENSION ARE BEING OPERATED.

NEVER PLACE HANDS OR OTHER PARTS OF THE BODY NEAR HYDRAULIC LEAKS. OIL MAY PENETRATE SKIN CAUSING INJURY OR DEATH.

DO NOT OPERATE THE LEVELING SYSTEM OR USE THE DUMP OR RAISE BUTTONS IF THE VEHICLE IS MOVING IN EXCESS OF 5 MPH.

WEAR SAFETY GLASSES WHEN INSPECTING OR SERVICING THE SYSTEM TO PROTECT EYES FROM DIRT, METAL CHIPS, OIL LEAKS, ETC. FOLLOW ALL OTHER APPLICABLE SHOP SAFETY PRACTICES.

IMPORTANT: IF COACH IS EQUIPPED WITH A ROOM EXTENSION, READ ROOM EXTENSION SECTION BEFORE OPERATING LEVELING SYSTEM.

## HOW TO OBTAIN WARRANTY SERVICE

### THIS IS NOT TO BE INTERPRETED AS A STATEMENT OF WARRANTY

HWH CORPORATION strives to maintain the highest level of customer satisfaction. Therefore, if you discover a defect or problem, please do the following:

**FIRST:** Notify the dealership where you purchased the vehicle or had the leveling system installed. Dealership management people are in the best position to resolve the problem quickly. If the dealer has difficulty solving the problem, he should immediately contact the Customer Service Department, at HWH CORPORATION.

**SECOND:** If your dealer cannot or will not solve the problem, notify the Customer Service Department:  
HWH CORPORATION 2096 Moscow Rd. Moscow IA. 52760  
(563) 724-3396 OR (800) 321-3494. Give your name and address, coach manufacturer and model year, date the coach was purchased, or the date of system installation,

description of the problem, and where you can be reached during business hours (8:00 a.m. till 5:00 p.m. c.s.t.). HWH CORPORATION personnel will contact you to determine whether or not your claim is valid. If it is, HWH CORPORATION will authorize repair or replacement of the defective part, either by appointment at the factory or by the authorization of an independent service facility, to be determined by HWH CORPORATION. All warranty repairs must be performed by an independent service facility authorized by HWH CORPORATION, or at the HWH CORPORATION factory, unless prior written approval has been obtained from proper HWH CORPORATION personnel.

# CONTROL IDENTIFICATION

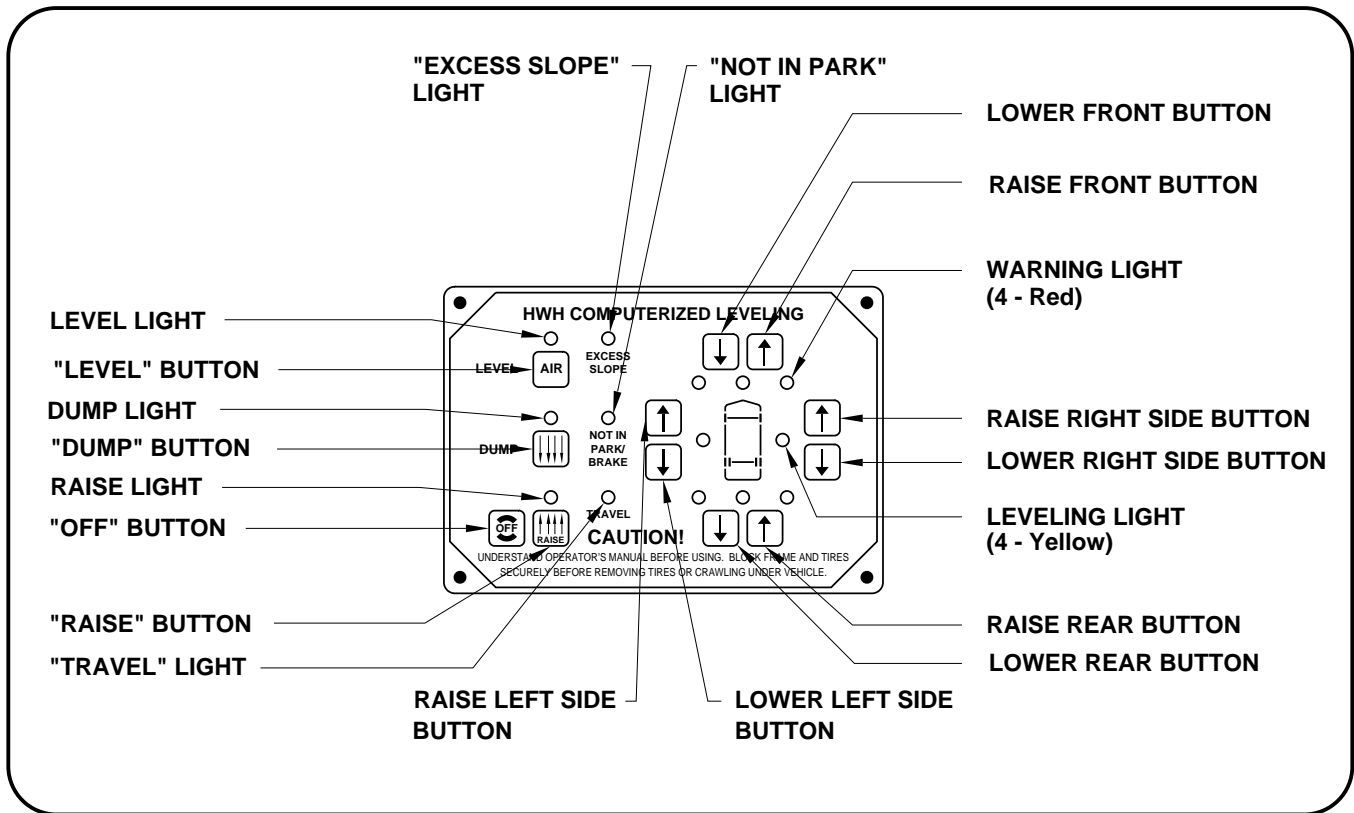

## CONTROL FUNCTIONS

### CONTROL BUTTONS

**"LEVEL" BUTTON:** This button is the system on button and automatic operation button. This will only work if the ignition is in the "ON" position.

**"OFF" BUTTON:** This button will turn the system OFF but does NOT control power to the "DUMP" or "RAISE" buttons.

**"DUMP" BUTTON:** This button will lower the whole coach by dumping air from the suspension system.

**"RAISE" BUTTON:** This button will raise the whole coach by adding air to the suspension system.

**UP ARROWS (RAISE BUTTONS):** These momentary buttons are used for manually operating the air leveling systems. Sides or ends of the vehicle will raise while these buttons are pushed.

**DOWN ARROWS (LOWER BUTTONS):** These momentary buttons are used to manually operate the air leveling systems. Sides or ends of the vehicle will lower while these buttons are pushed.

**IMPORTANT:** Read "DUMP AND RAISE FUNCTIONS" before using the "DUMP" or "RAISE" buttons.

### INDICATOR LIGHTS

**LEVEL LIGHT:** This light will be on when the system is on, and flash during automatic leveling.

**DUMP LIGHT:** This light will flash when the "DUMP" button is pushed.

**RAISE LIGHT:** This light will flash when the "RAISE" button is pushed.

**"EXCESS SLOPE" LIGHT:** This light will be on if the leveling system can NOT level the coach.

**"TRAVEL" LIGHT:** This light will be on if the leveling system is off and the ignition is in the "ON" position. See PREPARATION FOR TRAVEL".

**WARNING LIGHTS:** These lights will function only with the ignition key in the "ON" position. They will be on only if the system is on.

**LEVELING LIGHTS:** One or two yellow lights can be on indicating the side, end or corner of the coach is low.

**"NOT IN PARK/BRAKE" LIGHT:** This light will be on if the "AIR" button is pushed and the park brake is not set if the ignition switch is in the "ON" position. The system will not turn on.

## CONTROL IDENTIFICATION

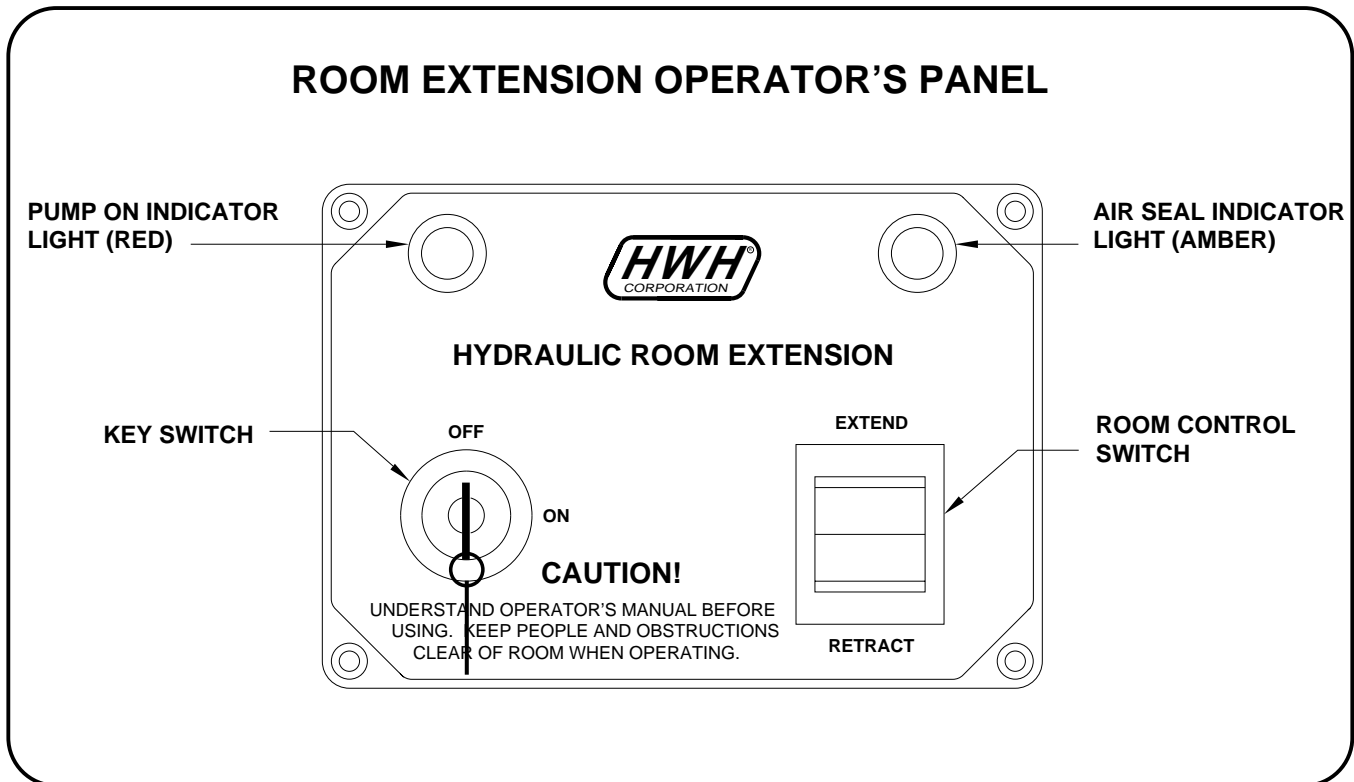

## CONTROL FUNCTIONS

**KEY SWITCH:** The KEY SWITCH controls power to the ROOM CONTROL SWITCH. When the KEY SWITCH is in the "ON" POSITION the room can be operated, and the key cannot be removed. When the KEY SWITCH is in the "OFF" position the room cannot be operated, and the key can be removed.

**AIR SEAL INDICATOR LIGHT:** This light will be on when it is ok to extend or retract the room extension.

**ROOM EXTENSION WARNING LIGHTS:** (This light is not part of the ROOM EXTENSION OPERATOR'S PANEL)  
This warning light will be on if a room is extended or unlocked and the ignition is on.

**ROOM CONTROL SWITCH:** The ROOM CONTROL SWITCH is a two position momentary switch. Pressing the switch in the EXTEND POSITION will extend the room. Pressing the switch in the RETRACT POSITION will retract the room. Releasing the ROOM CONTROL SWITCH will halt the operation of the room.

**PUMP ON INDICATOR LIGHT:** This light will be on when the pump is running.

---

# OPERATING PROCEDURES

---

## GENERAL INSTRUCTIONS

Press the "OFF" button at any time to stop the operation of the system.

**NOTE :** If the ignition switch is "ON" the vehicle's air suspension may return to travel height.

If the ignition is in the "ON" position and the hand/auto brake is not set, the "NOT IN PARK" light will come on and the system will not operate when the "AIR" button is pressed. The "NOT IN PARK" light will remain on only while the "AIR" button is pressed.

The "DUMP" and "RAISE" buttons will function with the system and park brake off. (See AIR DUMP AND RAISE FUNCTIONS.)

**CAUTION:** DO NOT MOVE THE COACH WHEN THE AIR BAGS ARE DEFLATED.

Do not operate the room extensions unless the coach is level.

## PREPARATION FOR TRAVEL

Start the vehicle's engine and allow air pressure to build to the recommended level for traveling. Before traveling, the "TRAVEL" light must be on.

If a room is not fully retracted or a room lock is not engaged, the transmission will not shift out of the neutral position.

**CAUTION:** IT IS THE OPERATOR'S RESPONSIBILITY TO VISUALLY MAKE SURE THE COACH IS AT THE PROPER RIDE HEIGHT AND THE ROOMS ARE FULLY RETRACTED BEFORE TRAVELING.

Rooms should be retracted and locked before allowing the coach to return to ride height.

## NEUTRAL HOLD OVERRIDE SWITCH

If a room is extended or unlocked, the transmission will not shift out of NEUTRAL.

If the rooms are fully retracted and locked and the transmission will not shift out of NEUTRAL, move the NEUTRAL OVERRIDE

toggle switch to the "ON" position. The switch is located in the control box. This will allow the transmission to be shifted. The system should be serviced as soon as possible.

---

# OPERATING PROCEDURES

---

## AIR OPERATION

### AUTOMATIC AIR OPERATION

**NOTE:** The ignition must be in the "ON" position to use the "AIR" button. Once the operation is started, the ignition can be moved to the "OFF" position and the operation will continue.

1. Place the transmission in the proper position for parking and set the park brake. The air leveling system can only be turned on if the ignition is in the "ON" position. Leaving the engine running during leveling is recommended. This will provide a better air supply for leveling. The vehicle will level with the engine shut off, however more time will be required for leveling.

**NOTE:** If the ignition key is in the "ON" position, the panel will not turn on if the park brake is not set. The "NOT IN PARK/BRAKE" light will come on while the "AIR" button is being pushed.

2. Press the "AIR" button once to enter the air mode. The AIR OPERATION indicator light will glow steady. When the ignition is in the "ON" position, the four red WARNING lights on the panel will come on. This indicates that the height control valves have been locked out. The vehicle should not be moved when these lights are on.

3. Press the "AIR" button a second time. The AIR OPERATION indicator light will start flashing and air leveling will begin. The system will attempt to level the vehicle by exhausting air from

the air bags. If a level position is not achieved by lowering the vehicle, the low side and/or end of the vehicle will be raised by adding air to the air bags. When all four LEVEL SENSING lights are out the leveling is complete. The AIR OPERATION indicator light will stop flashing, but will remain on. If there are no LEVEL SENSING lights on when air leveling is started, the AIR OPERATION indicator light will flash for 3 seconds and then will be on steady.

When the AIR OPERATION indicator light is on steady, the processor will be in a sleep mode for 30 minutes. The light will remain on. The vehicle's engine may now be turned off. After 30 minutes the processor will recheck the level indicators. If a level indicator is observed for 1 minute, the AIR OPERATION indicator light will start flashing and the system will level the vehicle and return to the SLEEP MODE. This will continue until the system is turned off by pushing the "OFF" button or by releasing the park brake if the ignition is in the "ON" position.

**EXCESS SLOPE:** The system will attempt to level the vehicle for approximately 45 minutes. After the 45 minutes, if a LEVEL SENSING light is still on, the "EXCESS SLOPE" light will come on. The AIR OPERATION indicator light will be on steady, but the system will not go into the SLEEP MODE. Turn the system off.

**NOTE:** At any time the ignition switch is in the "ON" position and the panel is off, the vehicle may return to travel height.

---

# OPERATING PROCEDURES

---

## AIR OPERATION (Cont'd)

### MANUAL AIR OPERATION

**NOTE:** The ignition must be in the "ON" position to use the "AIR" button. Once the operation is started, the ignition can be moved to the "OFF" position and the operation will continue.

1. Place the transmission in the proper position for parking and set the park brake. The air leveling system can only be turned on if the ignition is in the "ON" position. Running the vehicle engine during air leveling is recommended. This will provide a better air supply for leveling. The vehicle will level with the engine shut off, however more time will be required for leveling.

**NOTE:** If the ignition key is in the "ON" position the panel will not turn on if the park brake is not set. The "NOT IN PARK/BRAKE" light will come on while the "AIR" button is being pushed.

2. Press the "AIR" button once to enter the air mode. The AIR OPERATION indicator light will glow steady. When the ignition is in the "ON" position, the four red WARNING lights on the panel will come on. This indicates that the height control valves

have been locked out. The vehicle should not be moved when these lights are on.

3. The vehicle can now be leveled using the RAISE (up arrow) and LOWER (down arrow) buttons on the right half of the panel in conjunction with the yellow LEVEL indicator lights. **Any side to side leveling should be done before leveling the vehicle front to rear.** Try leveling the vehicle by lowering the opposite side or end. If a level position is not achieved use the RAISE (up arrow) button to raise the low side or end. The yellow LEVEL indicator light indicates that side or end is low. When all yellow lights are out the vehicle is level.

**NOTE:** If the "DUMP" or "RAISE" buttons are pushed while manually leveling the vehicle with air, the system will latch into the dump or raise mode until the "OFF" button is pushed.

4. Turn the ignition to the "OFF" position.

5. Turn the system off.

### "DUMP" AND "RAISE" FUNCTIONS

The "DUMP" and "RAISE" functions are provided for operator convenience for purposes such as dumping air suspension when parked in the wind or raising or lowering the vehicle to avoid an obstacle.

The vehicles ignition must be in the ON position to use the "DUMP" or "RAISE" buttons. The park brake does not have to be set.

**IMPORTANT:** The "DUMP" and "RAISE" functions will latch in and remain on if the vehicle is moving at a speed less than approximately 5 MPH. If the speed exceeds 5 MPH, the "DUMP" or "RAISE" function will automatically turn off and the vehicle should return to ride height. The vehicle will not return to ride height unless the "OFF" button on the leveling system panel is pushed or the vehicle speed exceeds 5 MPH.

**CAUTION:** REREAD CAUTIONS ON THE FIRST PAGE OF THIS MANUAL. THE VEHICLE MAY DROP OR RAISE AND / OR MOVE FORWARD OR BACKWARD WITH OUT WARNING CAUSING INJURY OR DEATH.

DO NOT OPERATE THE VEHICLE OVER 5 MPH UNLESS THE AIR SUSPENSION IS AT THE PROPER HEIGHT FOR TRAVEL.

Press the "RAISE" or "DUMP" button as desired to raise or lower the vehicle. The "RAISE" function will perform better if the vehicle engine is running. The desired function will latch in when the button is pushed. The vehicle will raise or lower as far as the suspension will allow.

If the vehicle is moving faster than 5 MPH, the vehicle will raise or lower only while the button is being pushed. When the button is released, the vehicle will return to ride height.

The vehicle will return to ride height when the vehicle speed exceeds 5 MPH or if the "OFF" button on the touch panel is pushed.

If desired for clearing an obstacle the vehicle may be moved while in the "RAISE" or "DUMP" mode.

**DO NOT operate the vehicle over 5 MPH or for extended distances unless the air suspension is at the proper height for travel. The vehicle will not return to ride height until the "OFF" button is pushed or the vehicle exceeds 5 MPH.**

**CAUTION:** IT IS THE OPERATOR'S RESPONSIBILITY TO CHECK THAT THE VEHICLE IS AT THE PROPER RIDE HEIGHT FOR TRAVELING.

---

# OPERATING PROCEDURES

---

## LEVEL FLOOR ROOM EXTEND PROCEDURES

**IMPORTANT:** It is not recommended to extend the room if the coach is not level.

**NOTE:** The park brake must be set before the room can be extended.

**CAUTION:** IT IS THE OPERATOR'S RESPONSIBILITY TO ENSURE THAT ALL MOVING PARTS OF THE ROOM EXTENSION, THE MOVING SECTIONS OF THE FLOOR SYSTEM AND THE SURROUNDING AREAS ARE CLEAR OF PEOPLE AND OTHER OBSTRUCTIONS BEFORE EXTENDING OR RETRACTING THE ROOM.

**NOTE:** Make sure there is adequate clearance outside of the vehicle to fully extend the room.

**IMPORTANT:** This room is equipped with hydraulic room locking cylinders. The room can NOT be extended with the locks in place. Do NOT attempt to force the room out if the room locks will not disengage.

1. Turn the vehicle ignition to the "ON" position.
2. Insert the key in the ROOM OPERATOR'S PANEL KEY SWITCH and turn the key to the "ON" position. This will allow the room air seal to deflate.
3. Approximately twenty seconds after the KEY SWITCH is turned on, the AIR SEAL indicator light will come on. The room can now be extended.

**NOTE:** If the ROOM CONTROL SWITCH is pushed before the AIR SEAL light comes on, the room will not extend.

4. To extend the room, press and hold the ROOM CONTROL SWITCH in the "EXTEND" position. When the pump is running, the red PUMP ON light will be on. When the room is fully extended the sub floor will raise into position. The pump

will automatically shut off when the room and floor are fully extended. Release the switch after the pump has shut off.

**IMPORTANT:** If either side of the room stops moving, release the switch immediately. Never attempt to force the system.

**NOTE:** Releasing the ROOM CONTROL SWITCH will halt the operation of the room.

**ROOM AND FLOOR OPERATION:** When the KEY SWITCH is turned on, the air seal will deflate. Approximately 20 seconds after the KEY SWITCH is turned on, the AIR SEAL INDICATOR LIGHT will come on.

**NOTE:** Anytime the KEY SWITCH is on and the ignition is in the "ON" position the room air seal will deflate.

When the ROOM CONTROL SWITCH is pushed to "EXTEND" the room locks will disengage and the room will begin to extend. When the room is fully extended, the sub floor will then raise into position. The procedure is ended automatically. The ROOM CONTROL SWITCH can be released after the pump shuts off.

**IMPORTANT:** If the room is fully extended and the Pump On light stays on for more than 30 seconds, release the ROOM CONTROL SWITCH.

5. Turn the KEY SWITCH to the "OFF" position. The room air seal will inflate.
6. Remove the KEY to prevent undesired operation of the room.
7. Turn the ignition switch off.

**IMPORTANT:** IN THE EVENT OF ANY FAILURE OF THE ROOM EXTENSION SYSTEM CALL HWH CORPORATION, 1-800-321-3494, CUSTOMER SERVICE, FOR ASSISTANCE.



---

# OPERATING PROCEDURES

---

## LEVEL FLOOR ROOM RETRACT PROCEDURE

**IMPORTANT:** It is recommended that the vehicle is level and stable before retracting the room.

**NOTE:** The park brake must be set before the room can be retracted.

**CAUTION:** IT IS THE OPERATOR'S RESPONSIBILITY TO ENSURE THAT ALL MOVING PARTS OF THE ROOM EXTENSION, THE MOVING SECTIONS OF THE FLOOR SYSTEM AND THE SURROUNDING AREAS ARE CLEAR OF PEOPLE AND OTHER OBSTRUCTIONS BEFORE EXTENDING OR RETRACTING THE ROOM.

1. Turn the vehicle ignition to the "ON" position.
2. Insert the key in the ROOM OPERATOR'S PANEL KEY SWITCH and turn the key to the "ON" position. This will allow the room air seal to deflate.
3. Approximately twenty seconds after the KEY SWITCH is turned on, the AIR SEAL INDICATOR LIGHT will come on. The room can now be retracted.

**NOTE:** If the ROOM CONTROL SWITCH is pushed before the AIR SEAL light comes on, the room will not retract.

4. To retract the room, press and hold the ROOM CONTROL SWITCH in the "RETRACT" position. When the pump is running, the red PUMP ON light will be on. The sub floor will lower and the room will begin to retract. After the room has been fully retracted and the room locks have engaged, the pump will automatically shut off. Release the ROOM CONTROL SWITCH after the pump has shut off.

**IMPORTANT:** If either side of the room stops moving, release the switch immediately. Never attempt to force the system.

**NOTE:** Releasing the ROOM CONTROL SWITCH will halt the operation of the room.

**ROOM AND FLOOR OPERATION:** When the KEY SWITCH is turned on, the air seal will deflate. Approximately twenty seconds after the KEY SWITCH is turned on, the AIR SEAL INDICATOR LIGHT will come on.

**NOTE:** Any time the KEY SWITCH is on and the ignition is in the "ON" position, the room air seal will deflate.

When the ROOM CONTROL SWITCH is pushed to "RETRACT", the sub floor section will lower, then the room will start to retract. When the room is fully retracted, the room locks will engage. The pump will automatically shut off. Release the ROOM CONTROL SWITCH.

**IMPORTANT:** If the room is fully retracted and the Pump On light remains on for more than 30 seconds, release the ROOM CONTROL SWITCH.

5. Turn the KEY SWITCH to the "OFF" POSITION. The room air seal will inflate.
6. Remove the KEY to prevent undesired operation of the room.
7. Turn the ignition switch off.

**IMPORTANT:** IN THE EVENT OF ANY FAILURE OF THE ROOM EXTENSION SYSTEM CALL HWH CORPORATION, CUSTOMER SERVICE, 1-800-321-3494 FOR ASSISTANCE.

---

# OPERATING PROCEDURES

---

## BEDROOM EXTEND PROCEDURE

**The vehicle should be level before extending a room.**

1. The ignition key must be on and the park brake must be set for the room to be operated.

**CAUTION: KEEP PEOPLE AND OBSTRUCTIONS CLEAR OF ROOM WHEN OPERATING.**

**NOTE :** Make sure there is adequate clearance to fully extend the room.

2. Insert the KEY into the KEY SWITCH on the room extension operator's panel and turn it to the "ON" position. When the AIR SEAL INDICATOR LIGHT is on the room can be operated.

3. To extend the room, push and hold the ROOM CONTROL SWITCH in the EXTEND position. When the pump is running, the red PUMP ON light will be on. When the room is fully extended, the pump will automatically shut off. Release the ROOM CONTROL SWITCH.

**IMPORTANT:** If the room is fully extended and the Pump On light stays on for more than 30 seconds, release the ROOM CONTROL SWITCH.

**IMPORTANT:** IF EITHER SIDE OF THE ROOM STOPS MOVING, RELEASE THE ROOM CONTROL SWITCH IMMEDIATELY.

**NOTE :** Releasing the ROOM CONTROL SWITCH will halt the operation of the room.

4. Turn the KEY SWITCH to the "OFF" position and remove the key.

5. Turn off the ignition switch.

**IMPORTANT:** This room is equipped with hydraulic room locking cylinders. The room can NOT be extended with the locks in place. DO NOT attempt to force the room out if the room locks will not disengage.

## BEDROOM RETRACT PROCEDURE

**CAUTION: KEEP PEOPLE AND OBSTRUCTIONS CLEAR OF ROOM WHEN OPERATING.**

**The vehicle should be level before retracting a room.**

1. The ignition key must be on and the park brake must be set for the room to be operated.

2. Insert the KEY into the KEY SWITCH on the room extension operator's panel and turn it to the "ON" position. When the AIR SEAL INDICATOR LIGHT is on the room can be operated.

3. To retract the room, push and hold the ROOM CONTROL SWITCH in the RETRACT position. When the pump is running the red PUMP ON light will be on. When the room is fully retracted, the pump will automatically shut off. Release the ROOM CONTROL SWITCH.

**IMPORTANT:** If the room is fully retracted and the Pump On light remains on for more than 30 seconds, release the ROOM CONTROL SWITCH.

**IMPORTANT:** IF EITHER SIDE OF THE ROOM STOPS MOVING, RELEASE THE ROOM CONTROL SWITCH IMMEDIATELY.

**NOTE :** Releasing the ROOM CONTROL SWITCH will halt the operation of the room.

4. Turn the KEY SWITCH to the "OFF" position and remove the key.

5. Turn off the ignition switch.

**IN THE EVENT OF THE FAILURE OF THE ROOM TO RETRACT, CONTACT HWH CORPORATION CUSTOMER SERVICE AT 1-800-321-3494 FOR ASSISTANCE.**

---

# OPERATING PROCEDURES

---

## PREVOST H3-45 LEVEL FLOOR ROOM EXTENSION SEQUENCE ROOM EXTEND SEQUENCE

1. Ignition key must be in the "ON" position.
2. Park brake must be set.
3. Turn the room extension control panel key to "ON".
4. Any time the room extension key and ignition key is on, there is a +12 signal to the air seal valve. The valve will open and the air will exhaust from the seal.
5. After a 20 second delay, a ground signal will turn the amber indicator light on the room extension control panel on. The room extension will not operate until this light is on.
6. Push the Room Extension Control Switch to "EXTEND". This will send a +12 signal for the pump relay, the room extension solenoid valves and the lock/unlock solenoid valves from the control box. A +12 signal turns the red pump on light, on the room control panel, on when the pump is running.

**NOTE:** The room control switch must be held in the "EXTEND" position during the extend sequence. If the room control switch is released before the sequence is complete, the sequence will start over from Step 6 when the switch is pushed to extend again.

7. A +12 signal will open the room unlock valve. This valve will stay open during the complete extend sequence.

8. When the room lock pins are fully retracted, the room unlock limit switch arrangement will send a ground signal to the control box. The manifold pressure switch will send a ground signal to the control box when pump pressure reaches 3000 psi. The sequence will not continue until both signals are received by the control box.

**NOTE:** The room, floor and lock limit switches are not connected directly to the control box. The individual switches are connected to a central limit switch indicator box for each room. When the appropriate limit switches complete a +12 circuit for the limit switch box, the limit switch box supplies a ground signal to the control box so the sequence can continue.

9. When both the room unlock limit switches and the manifold pressure switch signals are received by the control box, a +12 signal will open the room extend solenoid valve.

10. When the room is fully extended, the room out limit switch arrangement sends a ground signal to the control box. The manifold pressure switch sends a ground signal to the control box when pump pressure reaches 3000 psi. The sequence will continue when both signals are received by the control box.

11. When both the room out limit switches and the manifold pressure switch signals are received by the control box, a +12 signal will open the floor up solenoid valve.

**NOTE:** The unlock valve and room extend valve are still open at this time.

12. When the floor is up in place, the floor up limit switch sends a ground signal to the control box. The manifold pressure switch sends a ground signal to the control box when pump pressure reaches 3000 psi.

13. When both the floor up limit switches and the manifold pressure switch signals are received by the control box, the pump will shut off, the room extend valve will close and the floor up valve will close. The red pump on light will shut off and the sequence is complete. The room control switch may be released.

**NOTE:** The unlock valve will stay open for 10 seconds after the pump shuts off, even if the room control switch is released.

14. The air seal will inflate when the room control key switch is turned off or if the ignition switch is turned off. The amber light on the room control panel will go out.

---

# OPERATING PROCEDURES

---

## PREVOST H3-45 LEVEL FLOOR ROOM EXTENSION SEQUENCE ROOM RETRACT SEQUENCE

1. Ignition key must be in the "ON" position.
2. Park brake must be set.
3. Turn the room extension control panel key to "ON".
4. Any time the room extension key and ignition key is on, there is a +12 signal to the air seal valve. The valve will open and the air will exhaust from the seal.
5. After a 20 second delay, a ground signal will turn the amber indicator light on the room extension control panel on. The room extension will not operate until this light is on.
6. Push the Room Extension Control Switch to "RETRACT". This will send a +12 signal for the pump relay, the room extension solenoid valves, and the lock/unlock solenoid valves from the control box. A +12 signal turns the red pump on light, on the room control panel, on when the pump is running.  
**NOTE:** The room control switch must be held in the "RETRACT" position during the retract sequence. If the room control switch is released before the sequence is complete, the sequence will start over from Step 6 when the switch is pushed to retract again.
7. A +12 signal will open the room extend valve and the floor down valve. The floor down valve will stay open during the complete retract sequence.
8. When the floor is completely retracted, the floor down limit switch arrangement will send a ground signal to the control box. The sequence will not continue until the signal is received by the control box.  
**NOTE:** The room, floor and lock limit switches are not connected directly to the control box. The individual switches are connected to a central limit switch indicator box for each room. When the appropriate limit switches complete a +12 circuit for the limit switch box, the limit switch box supplies a ground signal to the control box so the sequence can continue.
9. When the floor down limit switch signal is received by the control box, the room extend valve will close and a +12 signal will open the room unlock valve. This valve will stay open during the complete retract sequence. This assures the room lock pins stay retracted.
10. When the room lock pins are fully retracted, the room unlock limit switch arrangement will send a ground signal to the control box. The manifold pressure switch will send a ground signal to the control box when pump pressure reaches 3000 psi. The sequence will not continue until both signals are received by the control box.
11. When both the room lock limit switches and the manifold pressure switch signals are received by the control box, a +12 signal will open the room retract solenoid valve. This valve stays open until the room retract sequence is complete.
12. When the room is fully retracted, the room in limit switch arrangement sends a ground signal to the control box. The manifold pressure switch sends a ground signal to the control box when pump pressure reaches 3000 psi. The sequence will continue when both signals are received by the control box.
13. When both the room in limit switches and the manifold pressure switch signals are received by the control box, the +12 signal to the room unlock valve is turned off and the unlock valve closes.
14. A +12 signal opens the room lock valve.
15. When the room lock pins are fully extended, the room lock limit switch arrangement sends a ground signal to the control box. The manifold pressure switch sends a ground signal to the control box when pump pressure reaches 3000 psi.
16. When both the room lock limit switches and the manifold pressure switch signals are received by the control box, the pump will shut off. All solenoid valves will close. The red pump on light will shut off and the sequence is complete. The room control switch may be released.
17. The air seal will inflate when the room control key switch is turned off or if the ignition switch is turned off. The amber light on the room control panel will go out.

---

# OPERATING PROCEDURES

---

## PREVOST H3 - 45 BEDROOM EXTENSION SEQUENCE ROOM EXTEND SEQUENCE

1. Ignition key must be in the "ON" position.
2. Park brake must be set.
3. Turn the room extension control panel key to "ON".
4. Any time the room extension key and ignition key is on, there is a +12 signal to the air seal valve. The valve will open and the air will exhaust from the seal.
5. After a 20 second delay, a ground signal will turn the amber indicator light on the room extension panel on. The room extension will not operate until the light is on.
6. Push the Room Extension Control Switch to "EXTEND". This will send a +12 signal for the pump relay and the room extension solenoid valves from the control box. A +12 signal turns the room control panel red pump on light ON when the pump is running.

**NOTE:** The room control switch must be held in the "EXTEND" position during the extend sequence. If the room control switch is released before the sequence is complete, the sequence will start over from Step 6 when the switch is pushed to extend again.

7. A +12 signal will open the room unlock valve. This valve will stay open during the complete extend sequence.

8. When the room lock pins are fully retracted, the room unlock limit switch arrangement will send a ground signal to the control box. The manifold pressure switch will send a ground signal to the control box when pump pressure reaches 3000 psi. The sequence will not continue until both signals are received by the control box.

**NOTE:** The room and lock limit switches are not connected directly to the control box. The individual switches are connected to a central limit switch indicator box for each room. When the appropriate limit switches complete a +12 circuit for the limit switch box, the limit switch box supplies a ground signal to the control box so the sequence can continue.

9. When both the room unlock limit switches and the manifold pressure switch signals are received by the control box, a +12 signal will open the room extend solenoid valve.

10. When the room is fully extended, the room out limit switch arrangement sends a ground signal to the control box. The manifold pressure switch sends a ground signal to the control box when the pump pressure reaches 3000 psi. The sequence will continue when both signals are received by the control box.

11. When both the room out limit switches and the manifold pressure switch signals are received by the control box, the +12 signal to the room extend valve is turned off. The extend sequence is finished and the pump will shut off. The room control switch may be released.

12. The red pump on light will go out.

**NOTE:** The unlock valve will stay open for 10 seconds after the pump shuts off, even if the room control switch is released.

13. The air seal will inflate when the room control key switch is turned off or if the ignition switch is turned off. The amber light on the room control panel will go out.

---

# OPERATING PROCEDURES

---

## PREVOST H3 - 45 BEDROOM EXTENSION SEQUENCE ROOM RETRACT SEQUENCE

1. Ignition key must be in the "ON" position.
2. Park brake must be set.
3. Turn the room extension control panel key to "ON".
4. Any time the room extension key and ignition key is on, there is a +12 signal to the air seal valve. The valve will open and the air will exhaust from the seal.
5. After a 20 second delay, a ground signal will turn the amber indicator light on the room extension panel on. The room extension will not operate until the light is on.
6. Push the Room Extension Control Switch to "RETRACT". This will send a +12 signal for the pump relay and the room extension solenoid valves from the control box. A +12 signal turns the room control panel red pump on light ON when the pump is running.

**NOTE:** The room control switch must be held in the "RETRACT" position during the retract sequence. If the room control switch is released before the sequence is complete, the sequence will start over from Step 6 when the switch is pushed to retract again.

7. A +12 signal will open the room unlock valve. This valve will stay open during the complete retract sequence.

**NOTE:** Even though the room does not lock in the extended position, the system checks to make sure the locks are fully retracted before proceeding.

8. When the room lock pins are fully retracted, the room unlock limit switch arrangement will send a ground signal to the control box. The manifold pressure switch will send a ground signal to the control box when pump pressure reaches 3000 psi. The sequence will not continue until both signals are received by the control box.

**NOTE:** The room and lock limit switches are not connected directly to the control box. The individual switches are connected to a central limit switch indicator box for each room. When the appropriate limit switches complete a +12 circuit for the limit switch box, the limit switch box supplies a ground signal to the control box so the sequence can continue.

9. When both the room lock limit switches and the manifold pressure switch signals are received by the control box, a +12 signal will open the room retract solenoid valve.

10. When the room is fully retracted, the room in limit switch arrangement sends a ground signal to the control box. The manifold pressure switch sends a ground signal to the control box when the pump pressure reaches 3000 psi. The sequence will continue when both signals are received by the control box.

11. When both the room in limit switches and the manifold pressure switch signals are received by the control box, the +12 signal to the room unlock valve is turned off and the unlock valve closes.

12. A +12 signal opens the room lock valve.

13. When the room lock pins are fully extended, the room lock limit switch arrangement sends a ground signal to the control box. The manifold pressure switch sends a ground signal to the control box when pump pressure reaches 3000 psi.

14. When both the room lock limit switches and the manifold pressure switch signals are received by the control box, the pump will shut off. The red pump on light will shut off and the sequence is complete. The room control switch may be released.

15. The air seal will inflate when the room control key switch is turned off or if the ignition switch is turned off. The amber light on the room control panel will go out.

---

# MAINTENANCE

---

## LEVEL SENSING UNIT ADJUSTMENT

Level the vehicle by placing a circular bubble level in the center of the freezer floor or location within the vehicle that is to be level. With the vehicle level, adjust the sensing unit until all yellow lights are off. This is done by drawing up the corresponding screw if the sensing unit is mounted below the surface, as shown, or backing out the corresponding screw if the sensing unit is mounted above the surface. Bump the sensing unit to see that it has settled down in the level position.

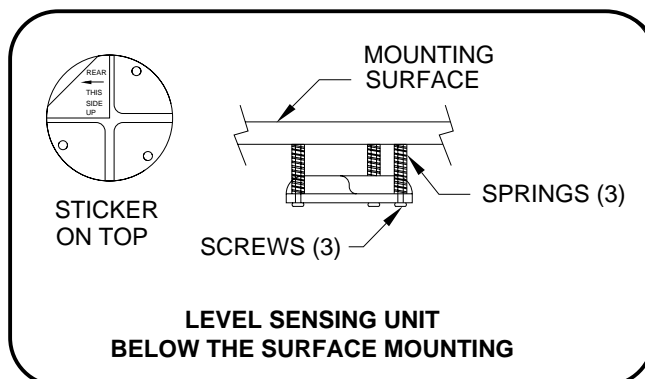

## "NOT IN PARK/BRAKE" CHECK

**CAUTION:** WHEN MAKING THIS CHECK, BLOCK THE VEHICLES WHEELS SECURELY SO THE VEHICLE CANNOT ROLL FORWARD OR BACKWARD.

Set the park brake. Switch the ignition to the "ON" position. Press the "AIR" button one time. Release the parking brake

and confirm that the "NOT IN PARK/BRAKE" indicator light comes on. Reset the parking brake. The "NOT IN PARK/BRAKE" indicator light should go out. Switch the ignition to "OFF".

## ROOM EXTENSION PNEUMATIC SEAL

Water leakage into the interior of the coach from around the room may indicate lack of continuous contact by the pneumatic seal around the room. This can result from a foreign object caught between the seal and mating surface,

a kinked seal, or lack of proper seal inflation. Visually inspect the seal and it's extended mating surface by looking across the top of the room from above the driver's seat.

**NOTE :** If any of the above checks or inspections reveal a problem or if there are other problems or questions, consult a qualified RV repair center, your vehicle or coach manufacturer or HWH CORPORATION (1-800-321-3494) for service or repair.

# HYDRAULIC LINE CONNECTION DIAGRAM

## PREVOST LEVEL FLOOR WITH LOCKS

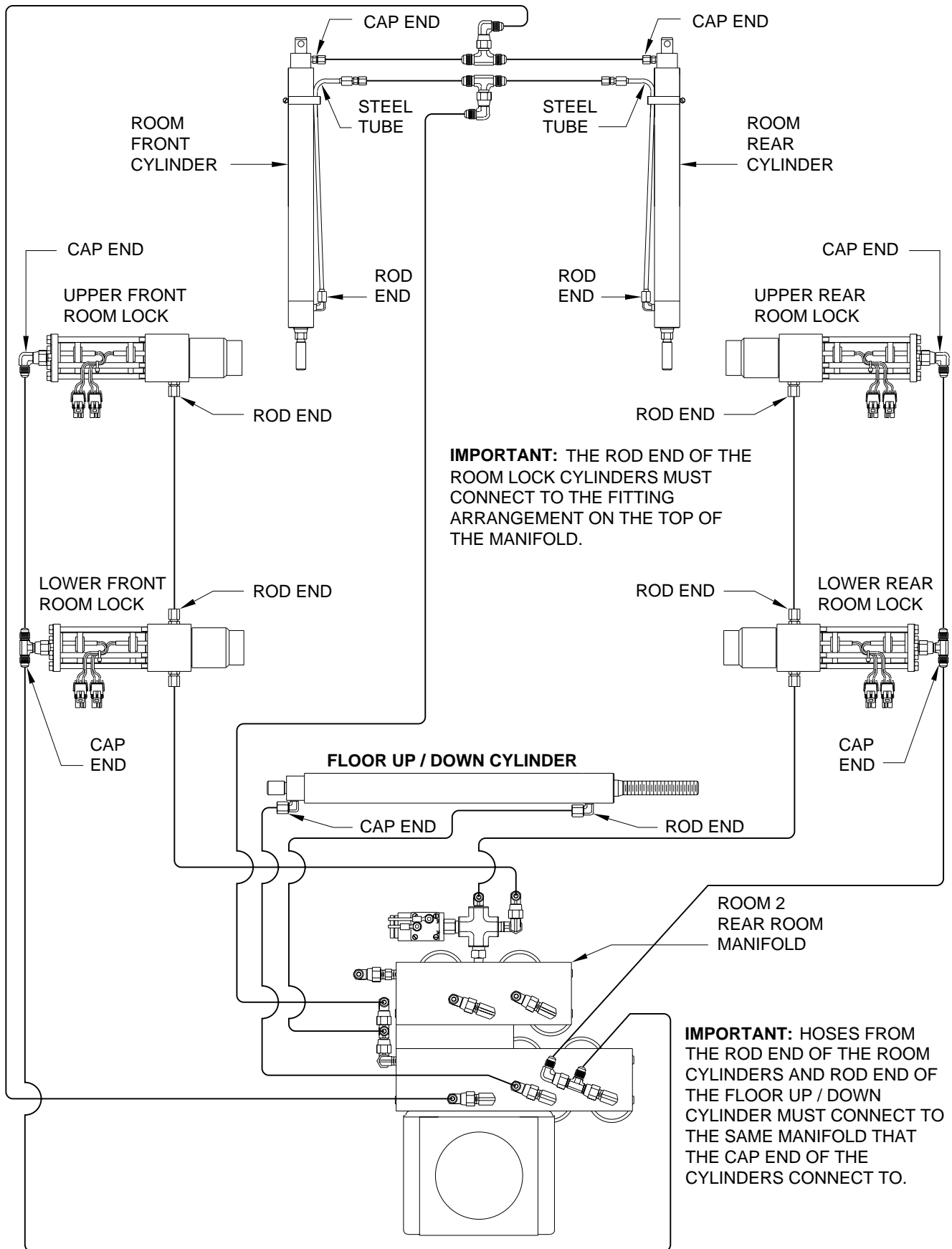

VIEW FROM TANK END



# HYDRAULIC LINE CONNECTION DIAGRAM PREVOST REAR ROOM WITH LOCKS

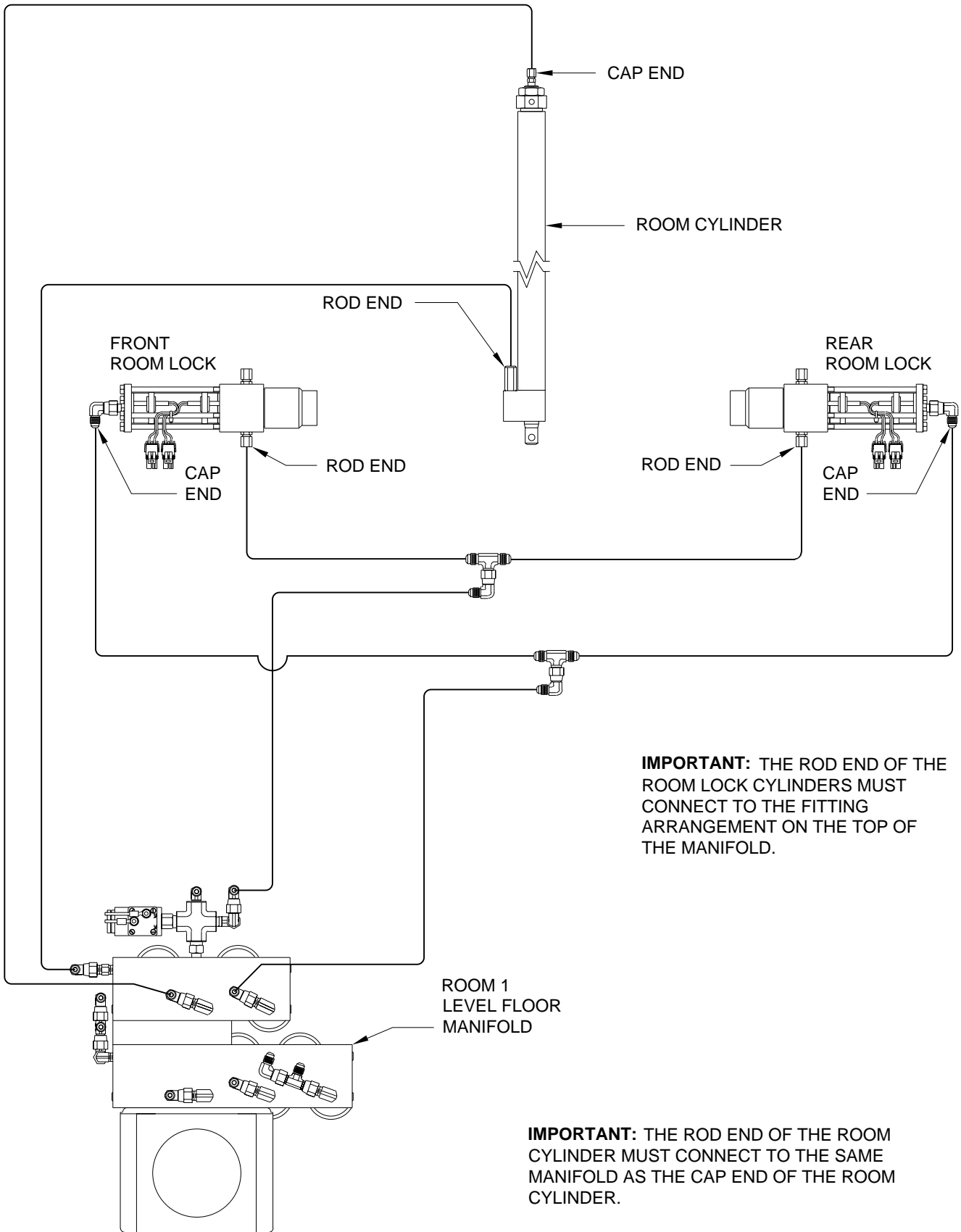

VIEW FROM TANK END

MP65.942F  
07APR00

# HYDRAULIC LINE CONNECTION DIAGRAM

## HYDRAULIC SOLENOID VALVE ARRANGEMENT

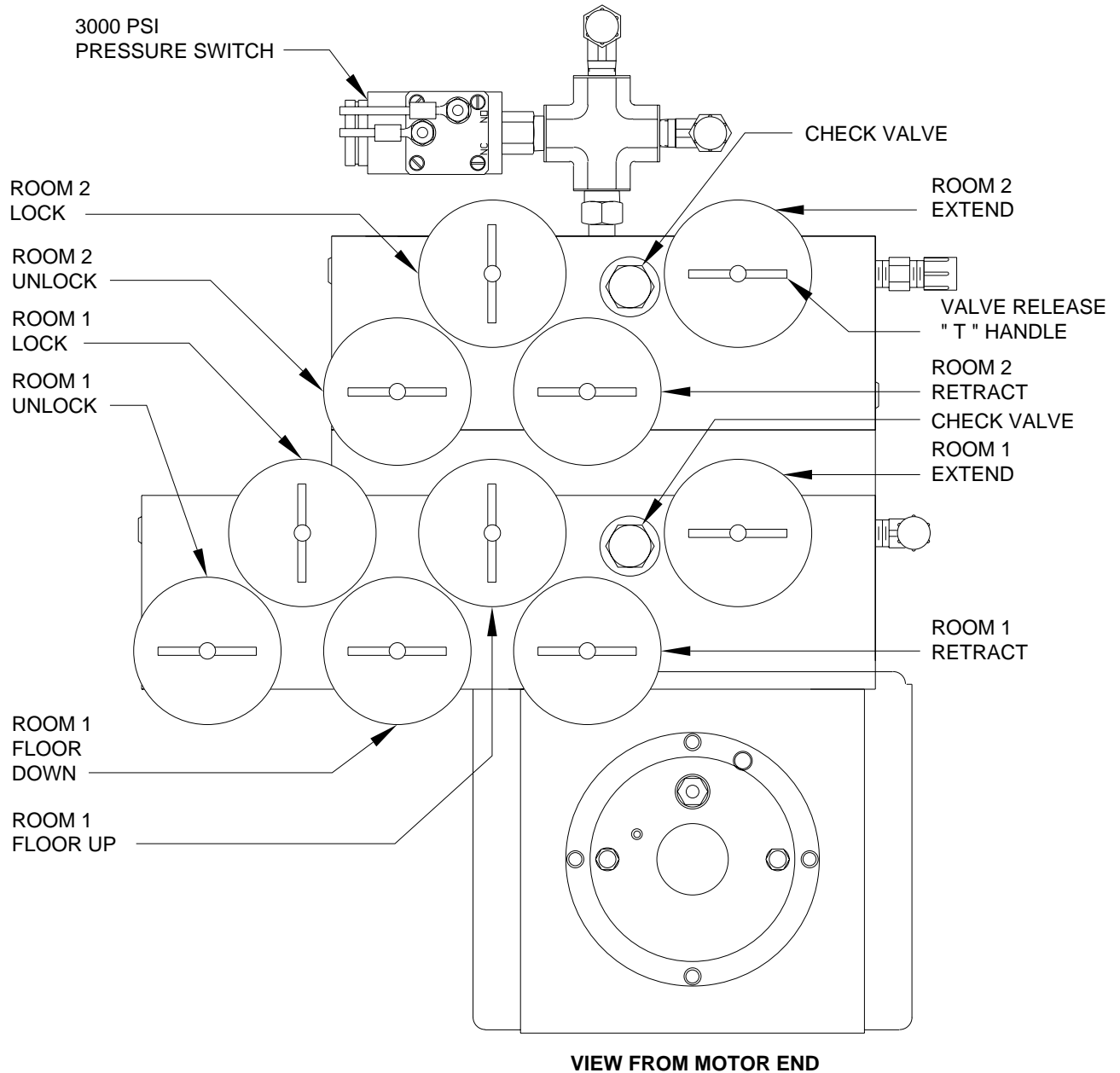

**HYDRAULIC FLOW DIAGRAM  
SINGLE CYLINDER ROOM EXTENSION  
STATIONARY POSITION**

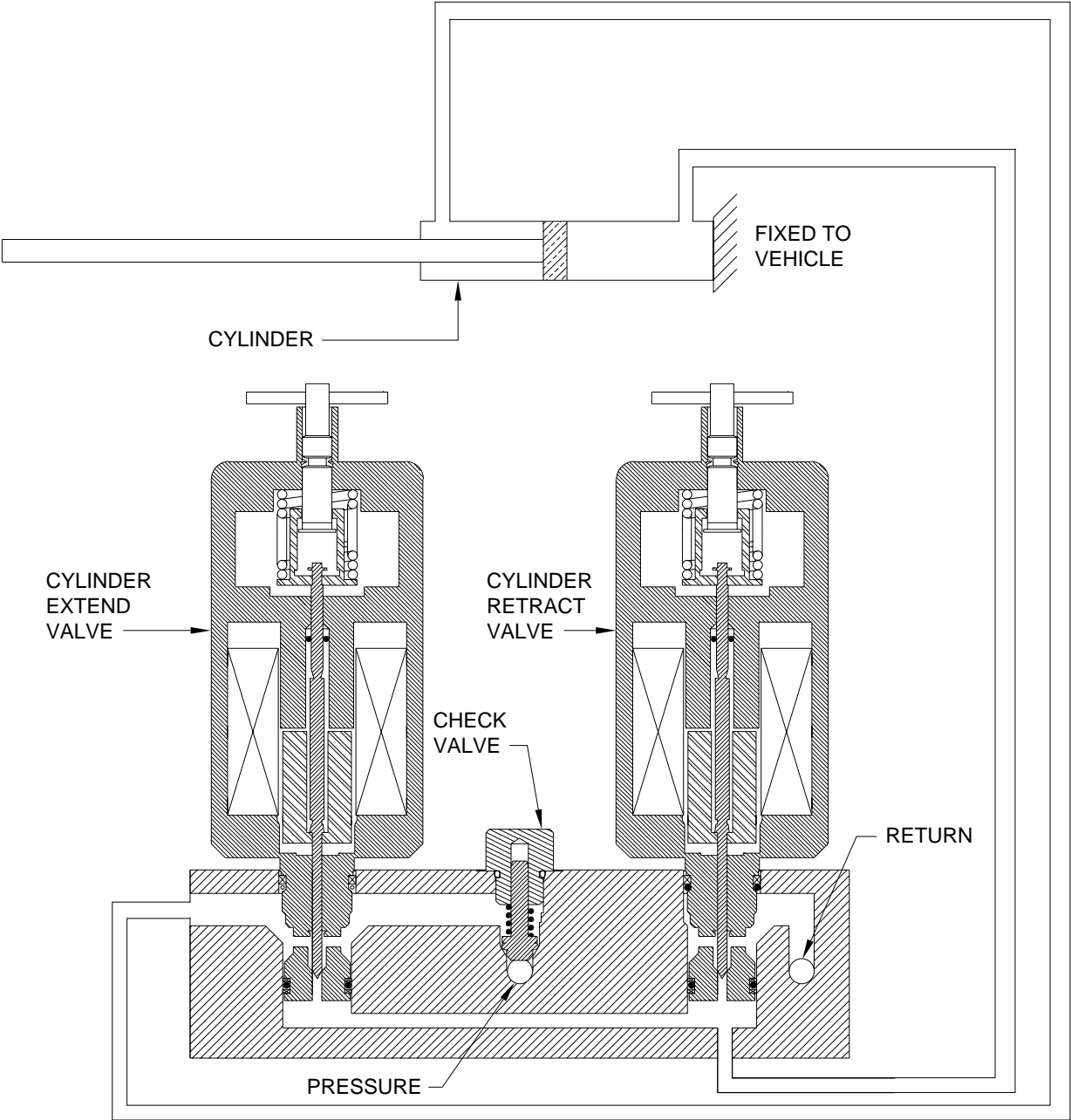

# AIR CONNECTION DIAGRAM WATER TRAP ASSEMBLY FOR 110 VOLT AIR COMPRESSOR

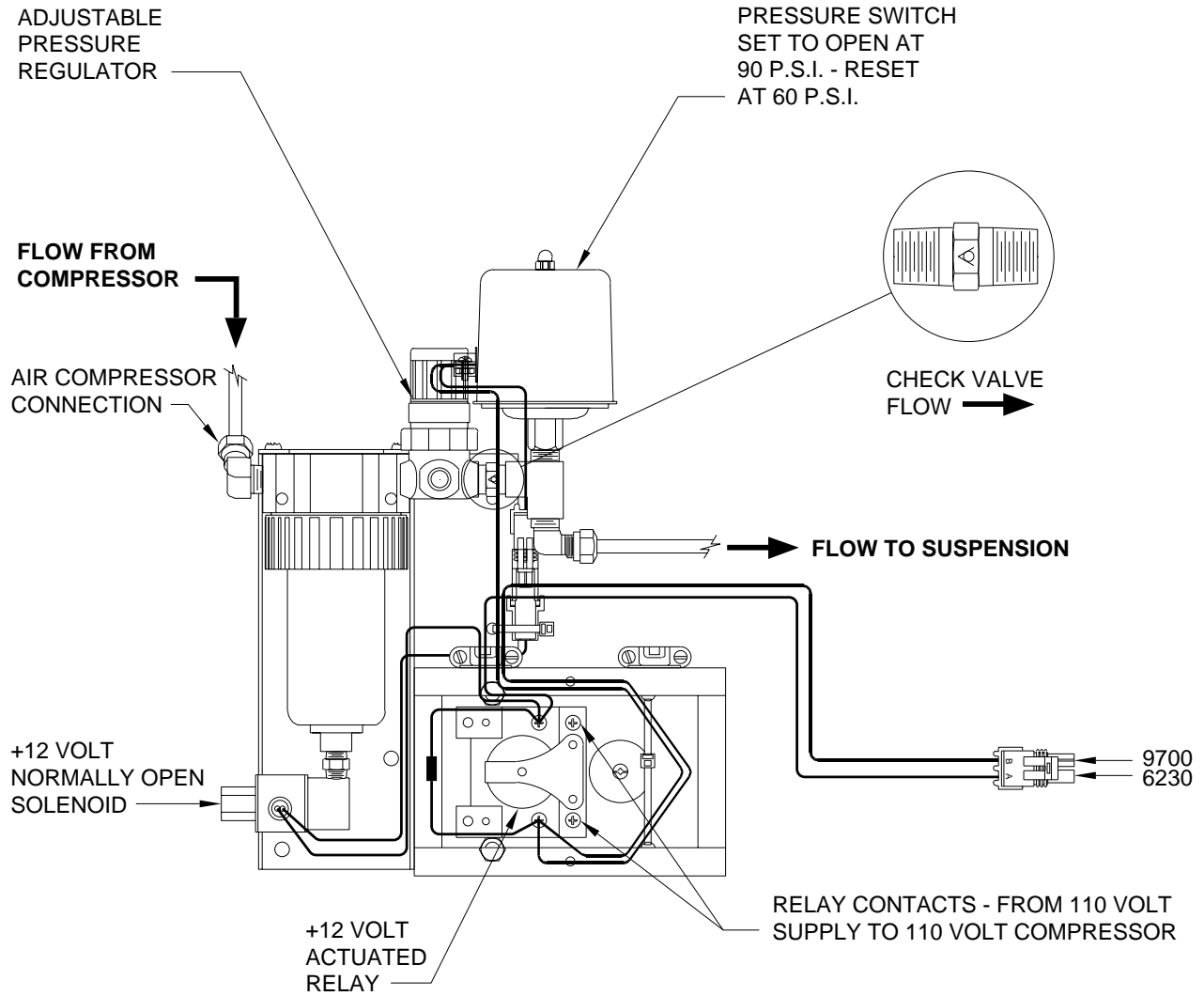

**NOTE:** FOR DETAILS OF THE ELECTRICAL CONNECTIONS BETWEEN THE WATER TRAP AND AIR COMPRESSOR SEE ELECTRICAL CONNECTION DIAGRAM - SCHEMATIC FOR WATER TRAP TO AIR COMPRESSOR WITH AUXILIARY PRESSURE SWITCH.

# AIR SEAL CONNECTION DIAGRAM



DETAIL A

CONNECTING  
HOSE

+12 VOLT  
3-WAY AIR VALVE

3-WAY

VACUUM

+12 VOLT NORMALLY  
CLOSED AIR VALVE

CHECK VALVE

FROM AIR  
SUPPLY

AIR SEAL  
MANIFOLD  
ASSEMBLY

AIR PRESSURE  
REGULATOR -  
SET AT 15 P.S.I.  
DO NOT CHANGE

**NOTE:** SOME VEHICLES ARE  
EQUIPPED WITH A +12 VOLT AIR  
COMPRESSOR THAT IS ONLY USED  
TO SUPPLY AIR FOR THE AIR SEAL.

WHEN THERE IS NO +12 POWER  
TO THE AIR VALVES CONSTANT  
AIR PRESSURE IS SUPPLIED TO  
THE AIR SEAL FROM THE AIR  
SUPPLY.

WHEN +12 IS SUPPLIED TO THE  
AIR VALVES, AIR WILL EXHAUST  
FROM THE AIR SEAL.

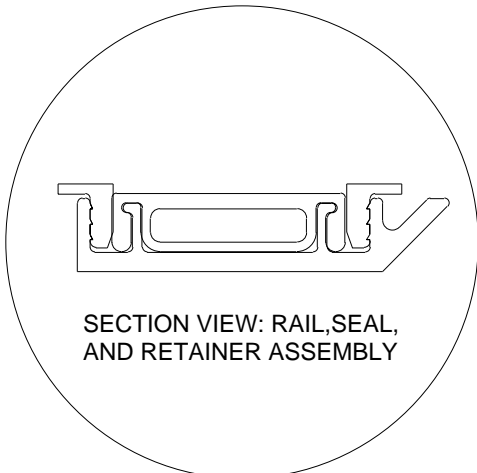

DETAIL A

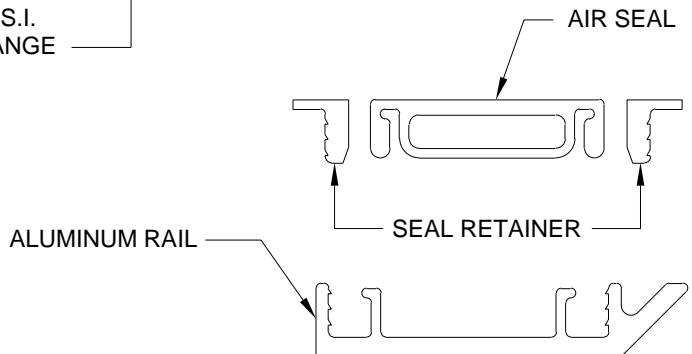

EXPLODED VIEW

# ELECTRICAL CONNECTION DIAGRAM ROOM EXTENSION OPERATOR'S PANEL

**NOTE:** CONNECTING HARNESSSES MAY BE SUPPLIED BY THE COACH CONVERTER.

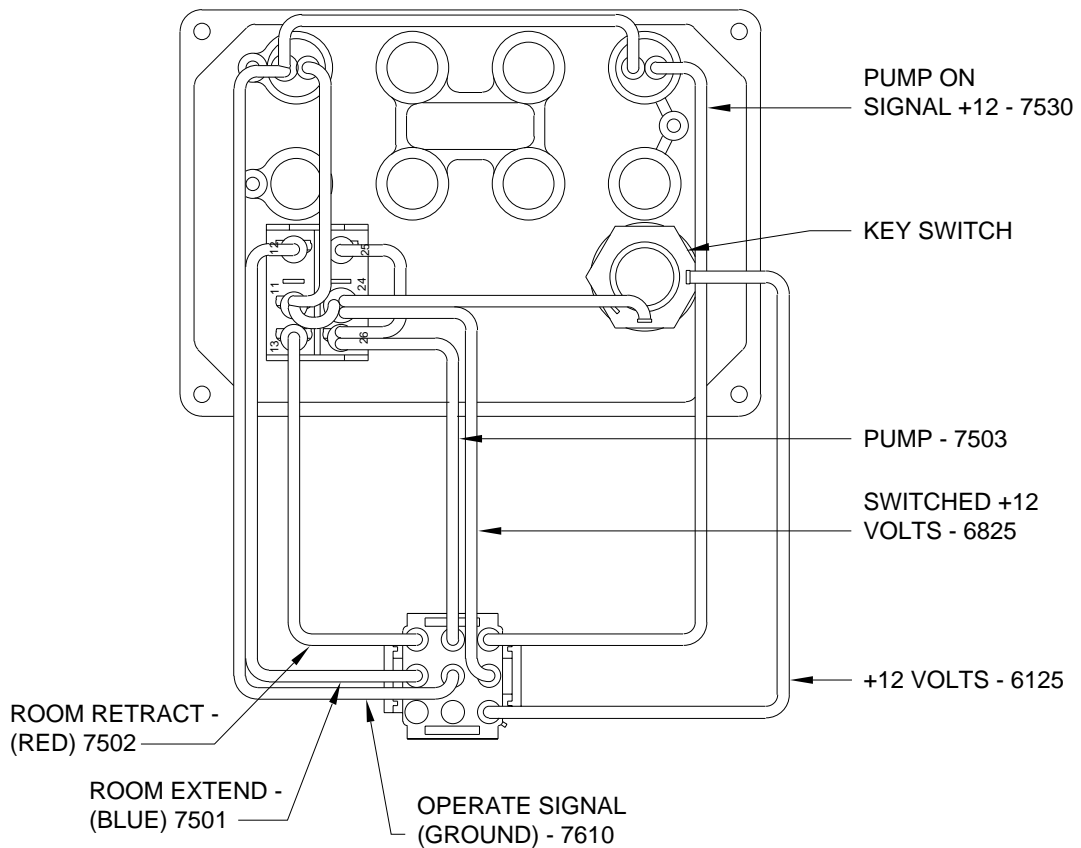
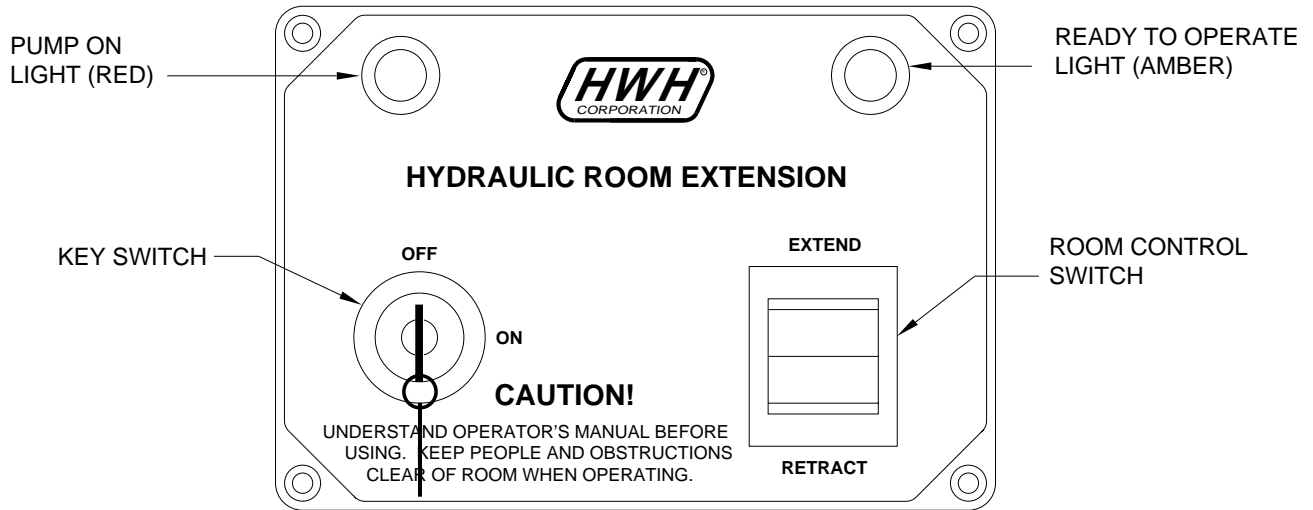

# CONTROL BOX CONNECTION DIAGRAM

**NOTE:** YELLOW LED'S "○" INDICATE ENERGIZED COIL ON OUTPUT RELAYS. RED LED'S "●" INDICATE OUTPUT FROM OUTPUT RELAYS THROUGH FUSE. SINGLE RED LED'S INDICATE EITHER ACTIVE OUTPUT OR INPUT.

TERMINAL NUMBER	FUSE VALUE	DESCRIPTION
-----------------	------------	-------------

22	N.A.	SPD. SW. INPUT
26 & 45	5A	PUMP OUTPUT
31 & 50	N.A.	PSW INPUT
61	10A	FRONT AIR SOL.
62	10A	RAISE AIR SOL.
63	10A	LR AIR SOL.
64	10A	RR AIR SOL.
65	10A	AIR COMP
67	7.5A	TRAVEL AIR SOL.
76	10A	UNLOCK SOL.
77	10A	EXTEND SOL.
78	10A	RETRACT SOL.
79	10A	FLOOR UP SOL.
80	10A	FLOOR DOWN SOL.
81	10A	LOCK SOL.
84	5A	AIR SEAL
85	10A	UNLOCK SOL.
86	10A	EXTEND SOL.
87	10A	RETRACT SOL.
90	10A	LOCK SOL.
93	5A	AIR SEAL

## TOP VIEW

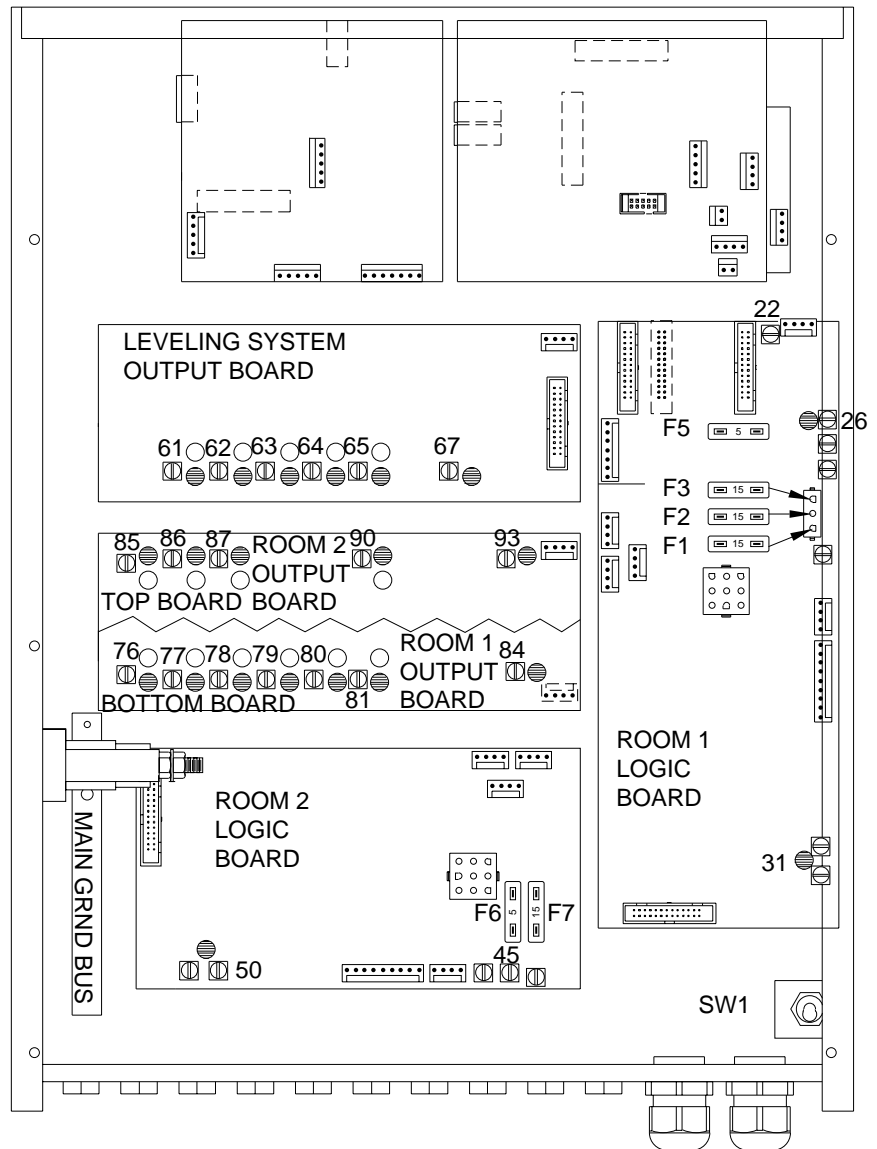

## FUSE DESIGNATION

- F1 - SW. IGNITION (15A) ROOM 1
- F2 - IGNITION (15A) +24V
- F3 - BATTERY (15A) +12V
- F5 - PUMP RELAY (5A) ROOM 1
- F6 - PUMP RELAY (5A) ROOM 2
- F7 - SW. IGNITION (15A) ROOM 2

**NOTE:** SW1 IS SET TO OFF POSITION TO ENABLE NEUTRAL HOLD FUNCTION.

# CONTROL BOX CONNECTION DIAGRAM

## AIR LEVELING

### (WITH TWO ROOM EXTENSIONS)

**CONNECTION INFORMATION  
WITH  
WARNING / PRESSURE  
SWITCH PIN DESIGNATION**

- 11 - TOUCH PANEL INTERFACE CABLE
- 21 - ROOM 1 LIMIT SWITCH HARNESS
  - PIN 1 - FLOOR UP - 5762
  - PIN 2 - FLOOR DOWN - 5764
  - PIN 3 - NOT USED
  - PIN 4 - ROOM LOCKED - 5758
  - PIN 5 - ROOM IN - 5752
  - PIN 6 - ROOM OUT - 5750
  - PIN 7 - NOT USED
  - PIN 8 - ROOM UNLOCKED - 5754
  - PIN 9 - GROUND - 6230
- 22 - SPEED SWITCH - 9900
- 26 & 45 - HYD. PUMP CONTROL - 8600
- 28 - PARK BRAKE INPUT - 9000
- 29 - POWER HARNESS
- 30 & 96 - +12 IGNITION
- 31 & 50 - SYS. PRESS. SW. INPUT - 8100
- 33 - ROOM 1 CONTROL PANEL
  - PIN 1 - +12 IGNITION - 6125
  - PIN 2 - PUMP ON LIGHT - 7530
  - PIN 5 - READY TO OP. LIGHT - 7610
- 47 - ROOM 2 LIMIT SWITCH HARNESS
  - PIN 1 - NOT USED
  - PIN 2 - NOT USED
  - PIN 3 - NOT USED
  - PIN 4 - ROOM LOCKED - 5758
  - PIN 5 - ROOM IN - 5752
  - PIN 6 - ROOM OUT - 5750
  - PIN 7 - NOT USED
  - PIN 8 - ROOM UNLOCKED - 5754
  - PIN 9 - GROUND - 6230
- 51 - LEVEL SENSING UNIT
  - PIN 1 - RED (REAR)
  - PIN 2 - GREEN (RIGHT SIDE)
  - PIN 3 - BLACK (FRONT)
  - PIN 4 - YELLOW (LEFT SIDE)
  - PIN 5 - WHITE (GROUND)
- 94 - ROOM 2 CONTROL PANEL
  - PIN 1 - +12 IGNITION - 6125
  - PIN 3 - PUMP ON LIGHT - 7530
  - PIN 5 - READY TO OP. LIGHT - 7610

**NOTE:** YELLOW LED'S "○" INDICATE ENERGIZED COIL ON OUTPUT RELAYS. RED LED'S "●" INDICATE OUTPUT FROM OUTPUT RELAYS THROUGH FUSE. SINGLE RED LED'S INDICATE EITHER ACTIVE OUTPUT OR INPUT.

**TOP VIEW**

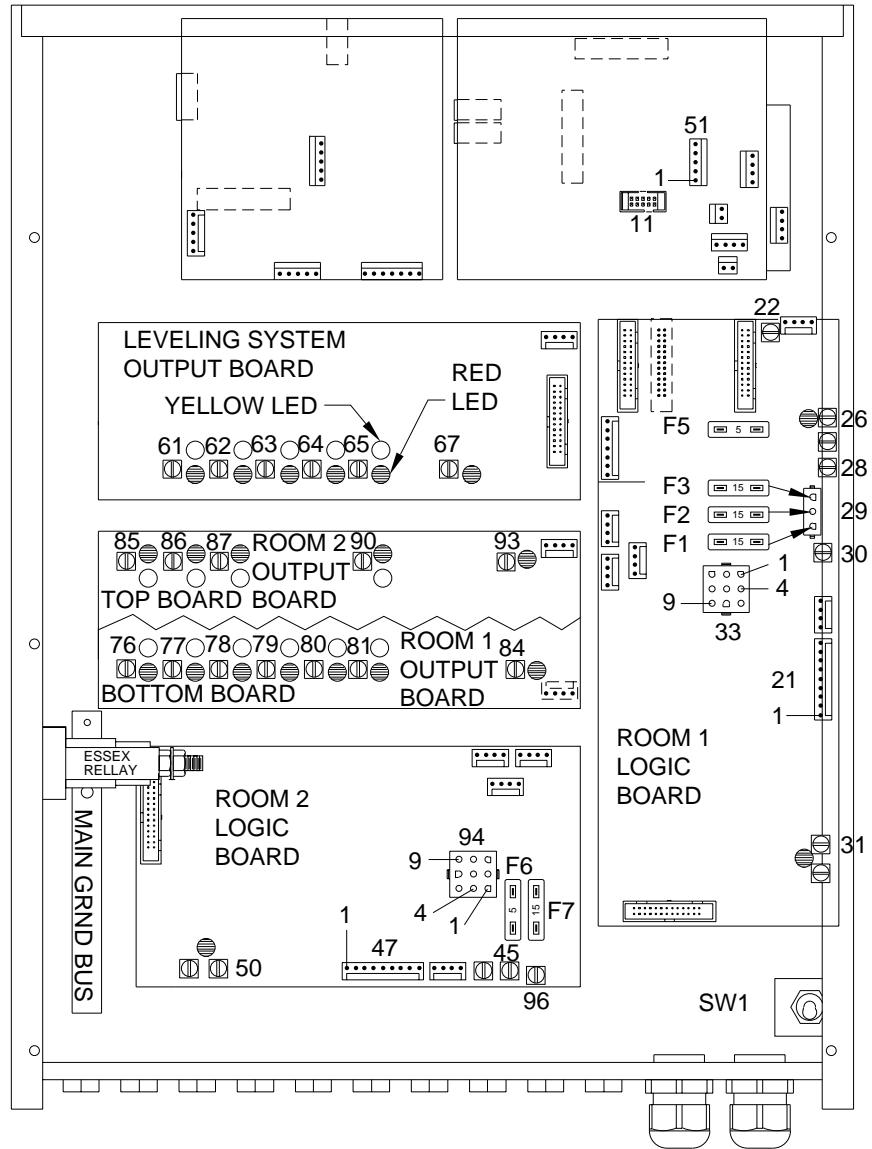

**FUSE DESIGNATION**

- F1 - SW. IGNITION (15A) ROOM 1
- F2 - IGNITION (15A) +24V
- F3 - BATTERY (15A) +12V
- F5 - PUMP RELAY (5A) ROOM 1
- F6 - PUMP RELAY (5A) ROOM 2
- F7 - SW. IGNITION (15A) ROOM 2

**NOTE:** SW1 IS SET TO OFF POSITION TO ENABLE NEUTRAL HOLD FUNCTION.



# CONTROL BOX CONNECTION DIAGRAM

## AIR LEVELING

### (WITH TWO ROOM EXTENSIONS)

#### ENTRY POINT

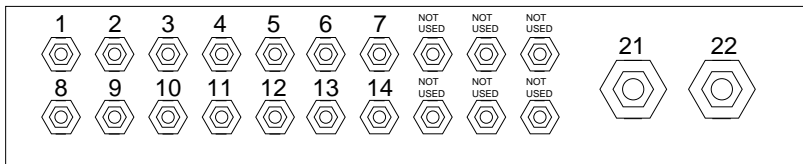

#### AIR LEVELING INFORMATION

		ENTRY POINT	TERMINAL CONNECTOR NUMBER	FUSE
AIR LEVEL HARNESS	COMPRESSOR CONTROL - 9700 (+12V)	21	65	10A
	LEFT REAR AIR VALVE - 9311 (+12V)	21	63	10A
	RIGHT REAR AIR VALVE - 9312 (+12V)	21	64	10A
	RAISE AIR VALVE - 9313 (+12V)	21	62	10A
	FRONT AIR VALVE - 9310 (+12V)	21	61	10A
	TRAVEL AIR VALVE- 9314 (+24V)	21	67	7.5A
POWER HARNESS	24V IGNITION - 6715	22	29	15A
	12V BATTERY - 6100	22	29	15A
WARNING INDICATOR PIGTAIL	TO LEVEL LOW INDICATOR - 9915	21	NA	N.A.
	FROM LEVEL LOW SWITCH - 9910	21	NA	NA
	ROOM 2 OUT/UNLOCKED WARNING INDICATOR - 7626	21	NA	NA
	+12V IGNITION - 6110	21	30	15A
	MASTER WARNING INDICATOR - 7699 (NOT USED)	21	NA	NA
	ROOM 1 OUT/UNLOCKED WARNING INDICATOR - 7625	21	NA	NA

#### WARNING INDICATOR CONNECTOR ( ENTRY POINT 21 )

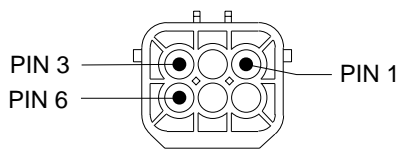

- PIN 1 - TO LEVEL LOW INDICATOR - 9915
- PIN 2 - FROM LEVEL LOW SWITCH - 9910
- PIN 3 - CONTROL ROOM 2 WRN LIGHT - 7626
- PIN 4 - +12 RE/WRN LIGHT - 6110
- PIN 5 - CONTROL MASTER WRN LIGHT - 7699 (NOT USED)
- PIN 6 - CONTROL ROOM 1 WRN LIGHT - 7625

#### AIR LEVEL HARNESS CONNECTOR ( ENTRY POINT 21 )

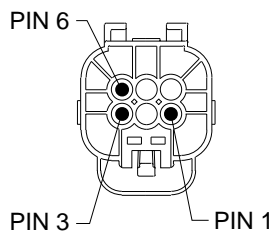

- PIN 1 - COMPRESSOR CONTROL - 9700
- PIN 2 - LEFT REAR AIR VALVE - 9311
- PIN 3 - RAISE AIR VALVE - 9313
- PIN 4 - TRAVEL AIR VALVE - 9314
- PIN 5 - RIGHT REAR AIR VALVE - 9312
- PIN 6 - FRONT AIR VALVE - 9310

#### SPEED SWITCH ( ENTRY POINT 21 )

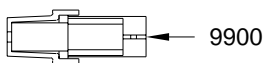

#### PARK BRAKE INPUT ( ENTRY POINT 21 )

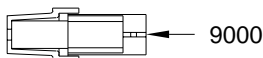

#### TRANSMISSION NEUTRAL HOLD (ENTRY POINT 21)

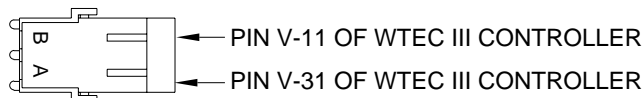

# CONTROL BOX CONNECTION DIAGRAM

## AIR LEVELING

### (WITH TWO ROOM EXTENSIONS)

#### ENTRY POINT

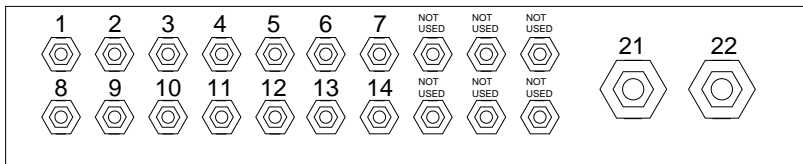

#### ROOM EXTENSION INFORMATION

	ENTRY POINT	TERMINAL CONNECTOR NUMBER	FUSE
ROOM 1 MANIFOLD HARNESS	ROOM 1 UNLOCK SOLENOID VALVE - 5300	1 76	10A
	ROOM 1 EXTEND SOLENOID VALVE - 5000	2 77	10A
	ROOM 1 RETRACT SOLENOID VALVE - 5100	3 78	10A
	ROOM 1 FLOOR UP SOLENOID VALVE - 5400	4 79	10A
	ROOM 1 FLOOR DOWN SOLENOID VALVE - 5500	5 80	10A
	ROOM 1 LOCK SOLENOID VALVE - 5200	6 81	10A
	ROOM 1 AIR SEAL CONTROL - 5600	7 84	5A
	PUMP RELAY CONTROL - 8600	13 45	5A
	PUMP RELAY GROUND - 6230	13 MAIN GRND BUS	NA
	SYSTEM PRESSURE SWITCH - 8100	14 50	NA
	SYSTEM GROUND - 6230	21 MAIN GRND BUS	NA
	+12V BATTERY FROM PUMP RELAY - 6100	22 ESSEX RELAY	40A
ROOM 2 MANIFOLD HARNESS	ROOM 2 UNLOCK SOLENOID VALVE - 5300	8 85	10A
	ROOM 2 EXTEND SOLENOID VALVE - 5000	9 86	10A
	ROOM 2 RETRACT SOLENOID VALVE - 5100	10 87	10A
	ROOM 2 LOCK SOLENOID VALVE - 5200	11 90	10A
	ROOM 2 AIR SEAL CONTROL - 5600	12 93	5A

#### ROOM 1 LIMIT SWITCH HARNESS CONNECTOR ( ENTRY POINT 22 )

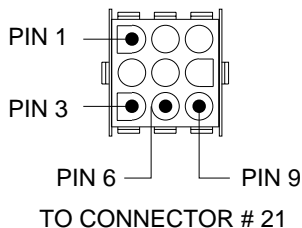

- PIN 1 - FLOOR UP - 5762
- PIN 2 - FLOOR DOWN - 5764
- PIN 3 - N.C.
- PIN 4 - ROOM LOCKED - 5758
- PIN 5 - ROOM IN - 5752
- PIN 6 - ROOM OUT - 5750
- PIN 7 - +12V IGNITION - 6120
- PIN 8 - ROOM UNLOCKED - 5754
- PIN 9 - GROUND - 6230

#### ROOM 2 LIMIT SWITCH HARNESS CONNECTOR ( ENTRY POINT 22 )

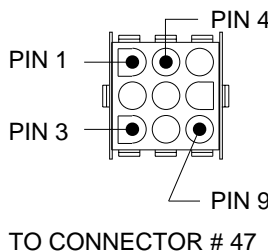

- PIN 1 - N.C.
- PIN 2 - N.C.
- PIN 3 - N.C.
- PIN 4 - ROOM LOCKED - 5758
- PIN 5 - ROOM IN - 5752
- PIN 6 - ROOM OUT - 5750
- PIN 7 - +12V IGNITION - 6120
- PIN 8 - ROOM UNLOCKED - 5754
- PIN 9 - GROUND - 6230

#### ROOM 1 OPERATOR PANEL HARNESS CONNECTOR ( ENTRY POINT 22 )

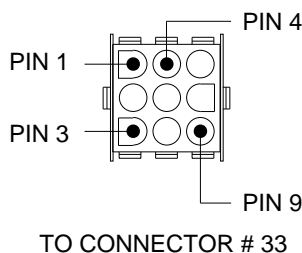

- PIN 1 - +12V IGNITION - 6125
- PIN 2 - +12 FROM PANEL - 6825
- PIN 3 - PUMP ON IND. LT. - 7530
- PIN 4 - N.C.
- PIN 5 - READY TO OP. LT. - 7610
- PIN 6 - PUMP CONTROL - 7503
- PIN 7 - N.C.
- PIN 8 - ROOM EXTEND - 7501
- PIN 9 - ROOM RETRACT - 7502

#### ROOM 2 OPERATOR PANEL HARNESS CONNECTOR ( ENTRY POINT 22 )

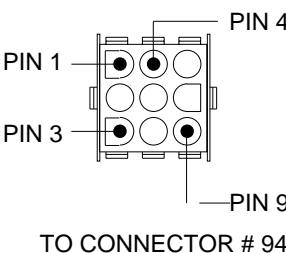

- PIN 1 - +12V IGNITION - 6125
- PIN 2 - +12 FROM PANEL - 6825
- PIN 3 - PUMP ON IND. LT. - 7530
- PIN 4 - N.C.
- PIN 5 - READY TO OP. LT. - 7610
- PIN 6 - PUMP CONTROL - 7503
- PIN 7 - N.C.
- PIN 8 - ROOM EXTEND - 7501
- PIN 9 - ROOM RETRACT - 7502

## WIRE NUMBER GLOSSARY

WIRE NUMBER	COLOR	DESCRIPTION
5000	BLACK	SWITCHED +12V TO OPERATE ROOM EXTEND VALVE
5100	BLACK	SWITCHED +12V TO OPERATE ROOM RETRACT VALVE
5200	BLACK	SWITCHED +12V TO OPERATE ROOM LOCK VALVE
5300	BLACK	SWITCHED +12V TO OPERATE ROOM UNLOCK VALVE
5400	BLACK	SWITCHED +12V TO OPERATE FLOOR UP VALVE
5500	BLACK	SWITCHED +12V TO OPERATE FLOOR DOWN VALVE
5600	BLACK	SWITCHED +12V TO OPERATE AIR SEAL VALVE OR MANIFOLD
5701	BLACK	SWITCHED +12V FROM ROOM OUT LIMIT SWITCH TO LIMIT SWITCH BOX
5703	BLACK	SWITCHED +12V FROM ROOM IN LIMIT SWITCH TO LIMIT SWITCH BOX
5704	BLACK	SWITCHED +12V FROM UPPER FRONT ROOM UNLOCK LIMIT SW. TO LIMIT SW. BOX
5705	BLACK	SWITCHED +12V FROM UPPER REAR ROOM UNLOCK LIMIT SW. TO LIMIT SW. BOX
5706	BLACK	SWITCHED +12V FROM LOWER FRONT ROOM UNLOCK LIMIT SW. TO LIMIT SW. BOX
5707	BLACK	SWITCHED +12V FROM LOWER REAR ROOM UNLOCK LIMIT SW. TO LIMIT SW. BOX
5708	BLACK	SWITCHED +12V FROM UPPER FRONT ROOM LOCK LIMIT SW. TO LIMIT SW. BOX
5709	BLACK	SWITCHED +12V FROM UPPER REAR ROOM LOCK LIMIT SW. TO LIMIT SW. BOX
5710	BLACK	SWITCHED +12V FROM LOWER FRONT ROOM LOCK LIMIT SW. TO LIMIT SW. BOX
5711	BLACK	SWITCHED +12V FROM LOWER REAR ROOM LOCK LIMIT SW. TO LIMIT SW. BOX
5713	BLACK	SWITCHED +12V FROM FLOOR UP LIMIT SWITCH TO LIMIT SWITCH BOX
5714	BLACK	SWITCHED +12V FROM FLOOR DOWN LIMIT SWITCH TO LIMIT SWITCH BOX
5750	BLACK	SWITCHED GRND FROM LIMIT SW. BOX TO CNTRL BOX FOR ROOM OUT LIMIT SWITCHES
5752	BLACK	SWITCHED GRND FROM LIMIT SW. BOX TO CNTRL BOX FOR ROOM IN LIMIT SWITCHES
5754	BLACK	SWITCHED GRND FROM LIMIT SW. BOX TO CNTRL BOX FOR ROOM UNLOCK LIMIT SW.
5758	BLACK	SWITCHED GRND FROM LIMIT SW. BOX TO CNTRL BOX FOR ROOM LOCK LIMIT SWITCHES
5762	BLACK	SWITCHED GRND FROM LIMIT SWITCH BOX TO CNTRL BOX FOR FLOOR UP LIMIT SWITCH
5764	BLACK	SWITCHED GRND FROM LIMIT SW. BOX TO CNTRL BOX FOR FLOOR DOWN LIMIT SWITCH
6100	RED	+12 VOLT FROM BATTERY
6110	RED	+12 VOLT FROM IGNITION THROUGH CONTROL BOX
6120	RED	+12 VOLT FROM CONTROL BOX FOR LIMIT SWITCH BOXES - IGNITION CONTROLLED
6125	RED	+12 VOLT FROM CONTROL BOX TO ROOM EXT. OPERATOR PANEL - IGN CONTROLLED
6230	WHITE	GROUND
6715	RED	+24 VOLT IGNITION
6825	BLACK	SWITCHED +12V FROM ROOM EXTENSION OPERATOR PANEL TO CONTROL BOX
7501	BLACK	SWITCHED +12V FROM ROOM EXTENSION PANEL TO CONTROL BOX TO EXTEND ROOM
7502	BLACK	SWITCHED +12V FROM ROOM EXTENSION PANEL TO CONTROL BOX TO RETRACT ROOM
7503	BLACK	SWITCHED +12V FROM ROOM EXTENSION PANEL TO CONTROL BOX TO OPERATE PUMP
7530	BLACK	SWITCHED +12V FROM CONTROL BOX TO ROOM EXTENSION PANEL FOR PUMP ON LIGHT
7610	BLACK	SWITCHED GRND FROM CNTRL BOX TO ROOM EXT. PANEL FOR READY TO OPER. LIGHT
7625	BLACK	SWITCHED GROUND FROM CONTROL BOX TO CONTROL ROOM 1 WARNING LIGHT
7626	BLACK	SWITCHED GROUND FROM CONTROL BOX TO CONTROL ROOM 2 WARNING LIGHT
8100	BLACK	SWITCHED GROUND FROM PRESS. SW. ON HYDRAULIC MANIFOLD TO CONTROL BOX
8600	BLACK	SWITCHED +12V FROM CONTROL BOX TO CONTROL PUMP RELAY
9000	BLACK	SWITCHED +24V FROM PARK BRAKE SWITCH TO CONTROL BOX
9310	BLACK	SWITCHED +12V TO OPERATE PREVOST FRONT AIR VALVE
9311	BLACK	SWITCHED +12V TO OPERATE PREVOST LEFT REAR AIR VALVE
9312	BLACK	SWITCHED +12V TO OPERATE PREVOST RIGHT REAR AIR VALVE
9313	BLACK	SWITCHED +12V TO OPERATE PREVOST RAISE AIR VALVE
9314	BLACK	SWITCHED +24V TO OPERATE PREVOST TRAVEL VALVE
9700	BLACK	SWITCHED +12V TO CONTROL AIR COMPRESSOR
9900	BLACK	TRANSMISSION SPEED SWITCH +24V FROM TRANSMISSION WHEN AT LOW SPEED
9910	BLACK	+24V IGNITION ROUTED FROM PREVOST LEVEL LOW SWITCH
9915	BLACK	SWITCHED +24V TO LEVEL LOW INDICATOR LIGHT
9955	BLACK	TRANSMISSION NEUTRAL HOLD B - COMPLETES CIRCUIT WITH 9961
9961	BLACK	TRANSMISSION NEUTRAL HOLD A - COMPLETES CIRCUIT WITH 9955

# ELECTRICAL CONNECTION DIAGRAM

## 680 SERIES HARNESS CONNECTIONS AT CONTROL BOX

### POWER - WARNING INDICATORS - AIR LEVEL - HYDRAULIC MANIFOLD

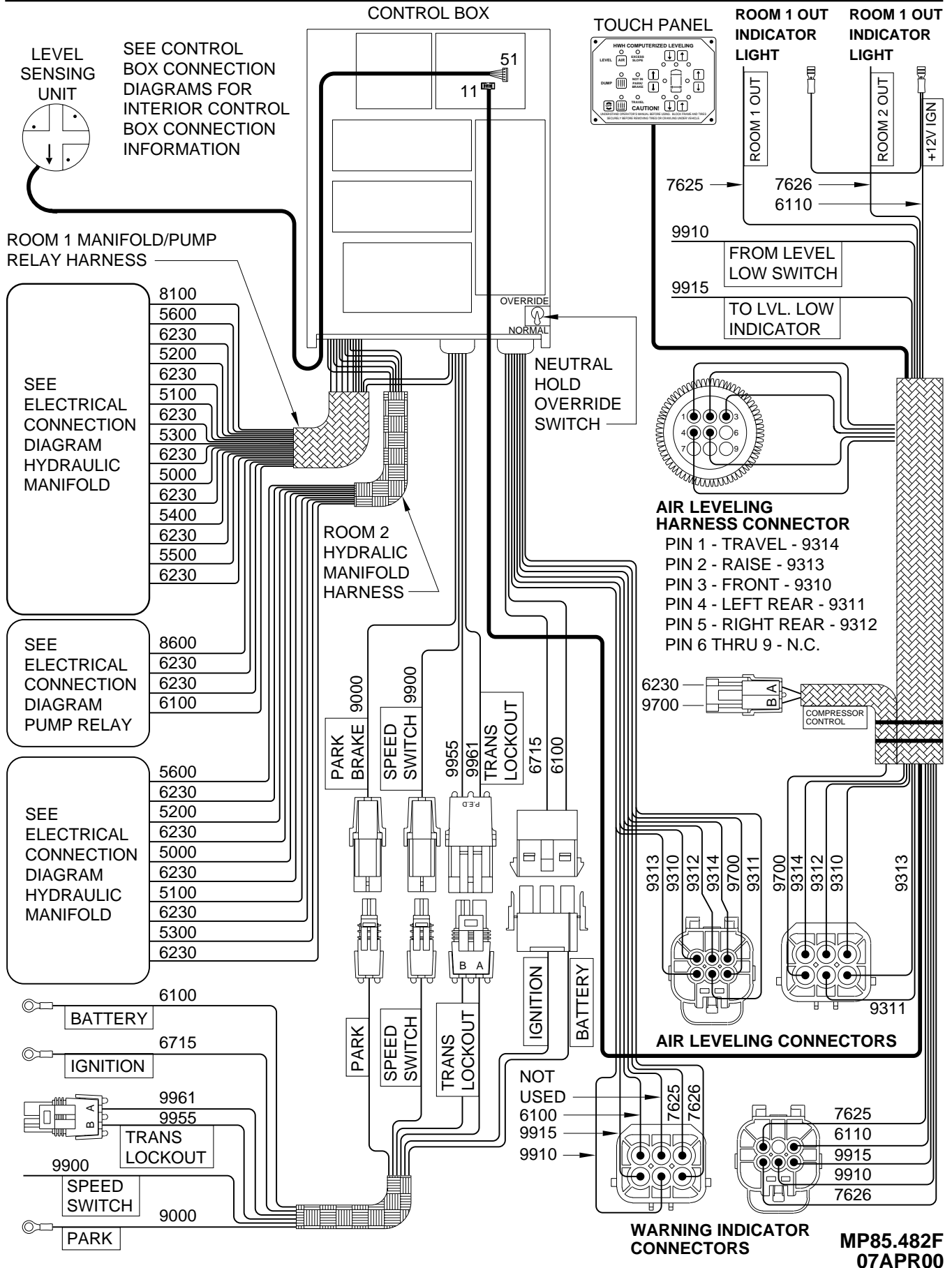

# ELECTRICAL CONNECTION DIAGRAM

## 680 SERIES HARNESS CONNECTIONS AT CONTROL BOX

### LEVEL FLOOR OPERATOR'S PANEL - LIMIT SWITCH INDICATOR BOXES

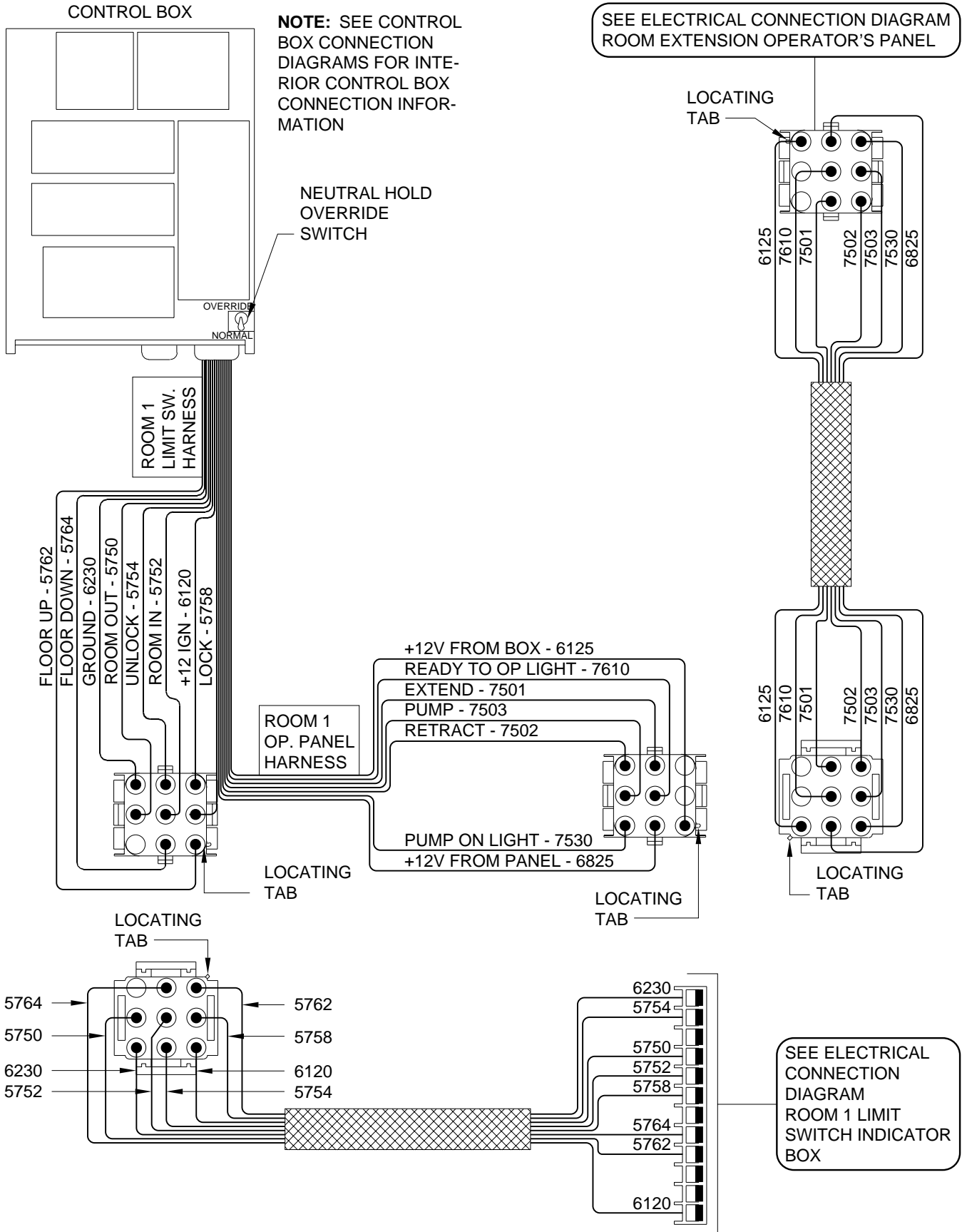

# ELECTRICAL CONNECTION DIAGRAM

## 680 SERIES HARNESS CONNECTIONS AT CONTROL BOX

### REAR ROOM OPERATOR'S PANEL - LIMIT SWITCH INDICATOR BOXES

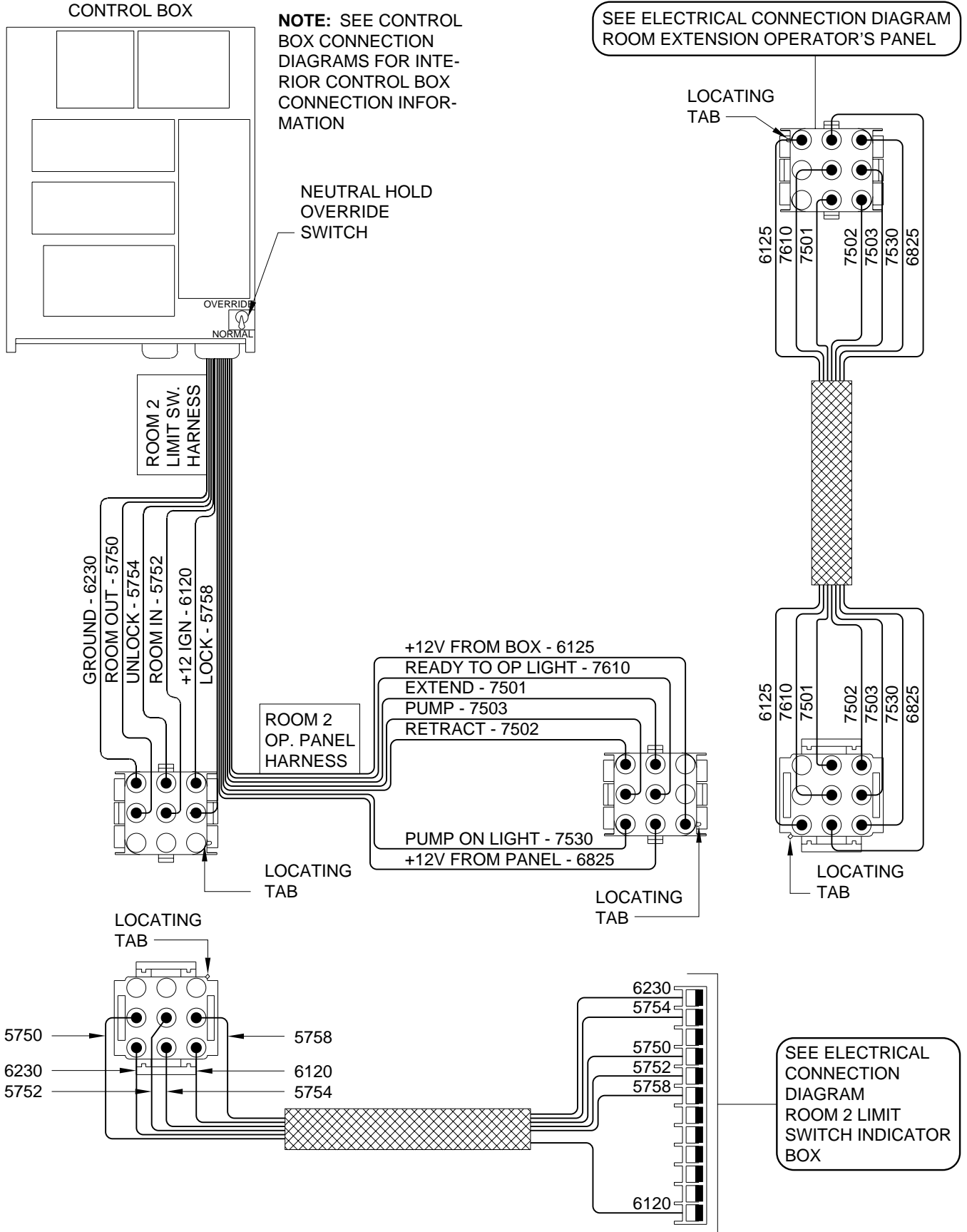

# ELECTRICAL CONNECTION DIAGRAM HYDRAULIC MANIFOLD

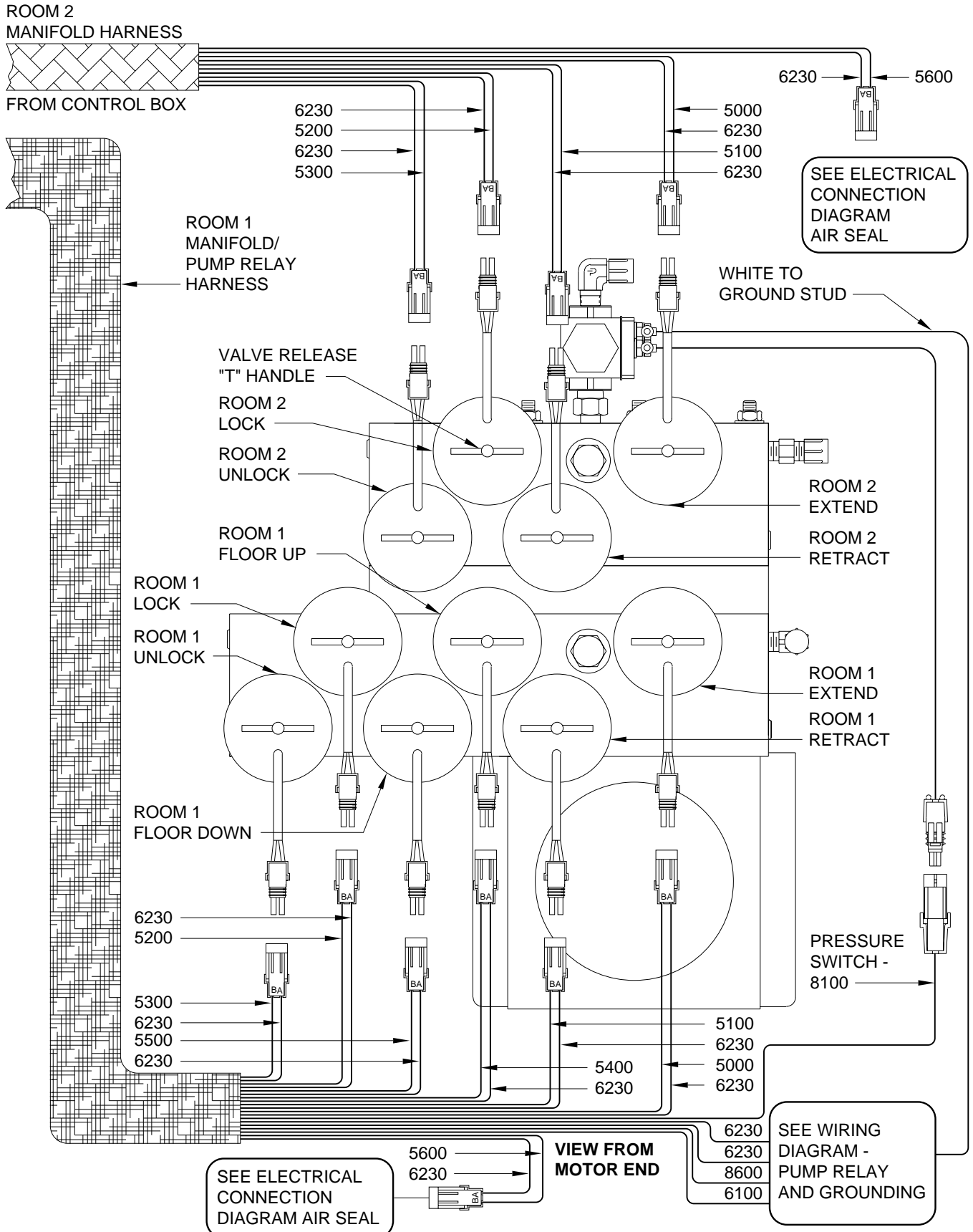

# ELECTRICAL CONNECTION DIAGRAM PUMP RELAY

**NOTE:** THE FOUR DIGIT WIRE NUMBER SUPERSEDES ANY AND ALL WIRE COLORS.

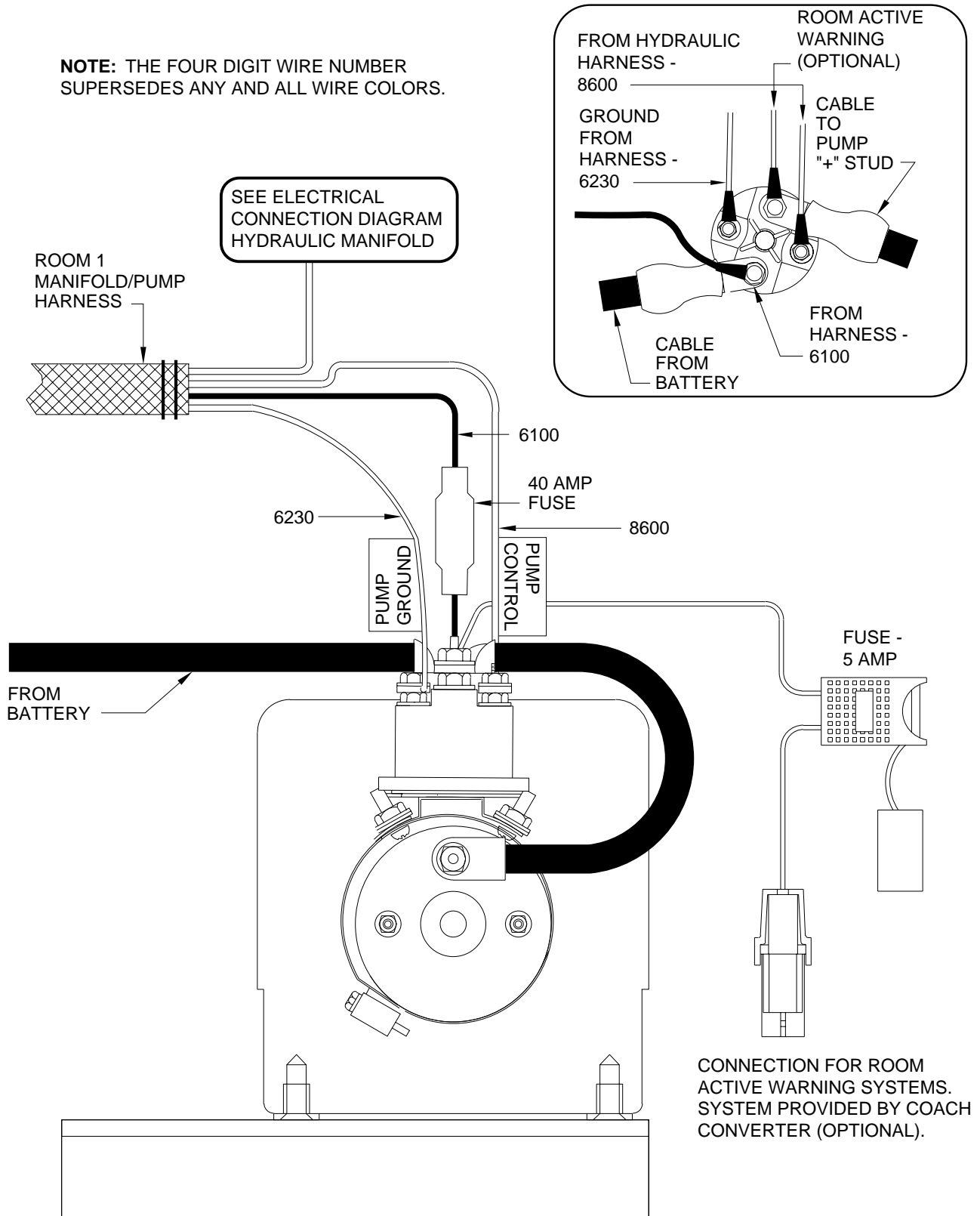



# ELECTRICAL CONNECTION DIAGRAM GROUNDING INSTRUCTIONS

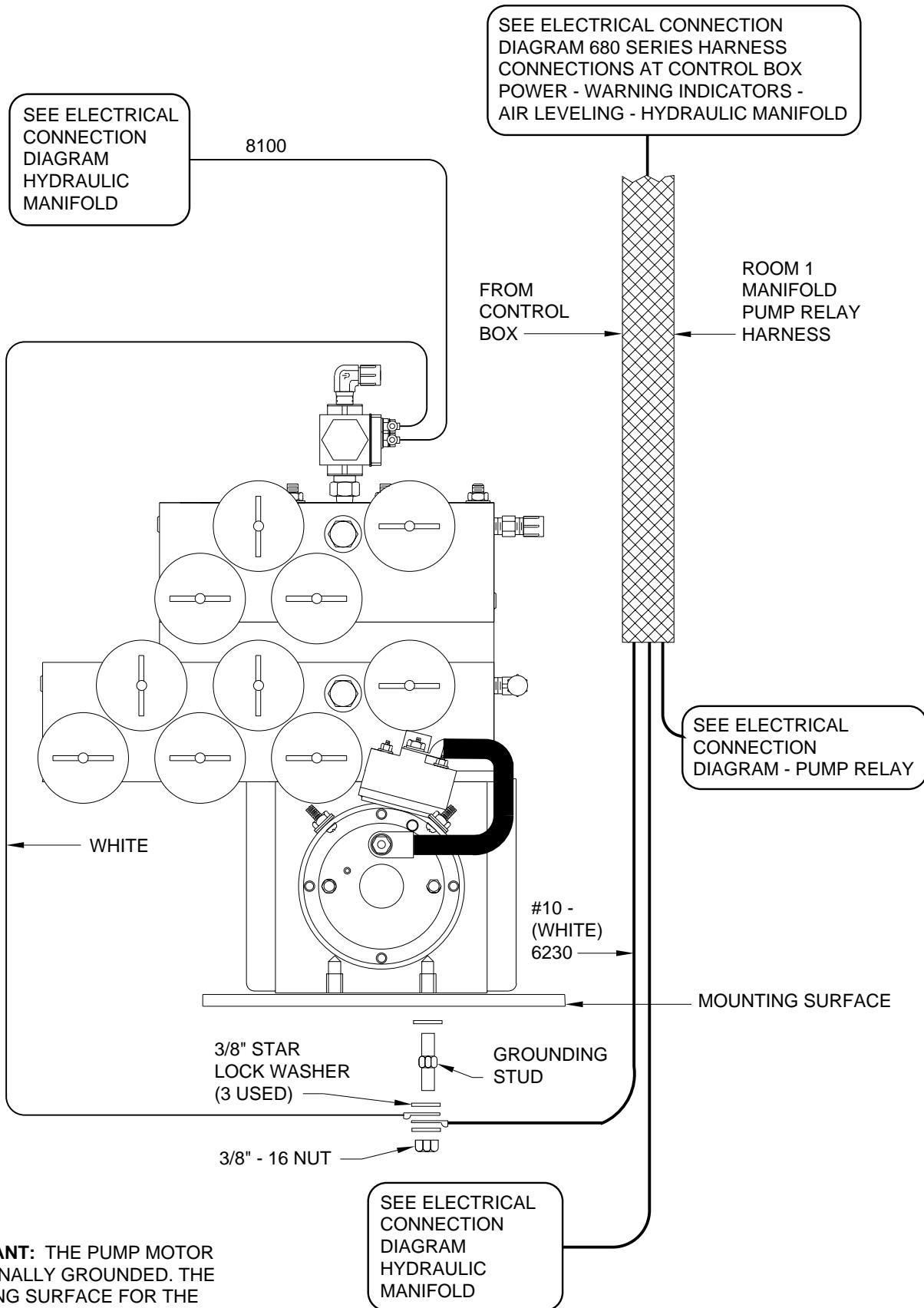

**IMPORTANT:** THE PUMP MOTOR IS INTERNALLY GROUNDED. THE MOUNTING SURFACE FOR THE PUMP AND GROUNDING STUD MUST BE A GOOD FRAME GROUND.

# ELECTRICAL CONNECTION DIAGRAM

## SCHEMATIC FOR WATER TRAP TO AIR COMPRESSOR (WITH AUXILIARY SYSTEM PRESSURE SWITCH)

AUXILIARY SWITCH ( WITH +12V CONTROL WIRE PROVIDED BY VEHICLE MANUFACTURER )

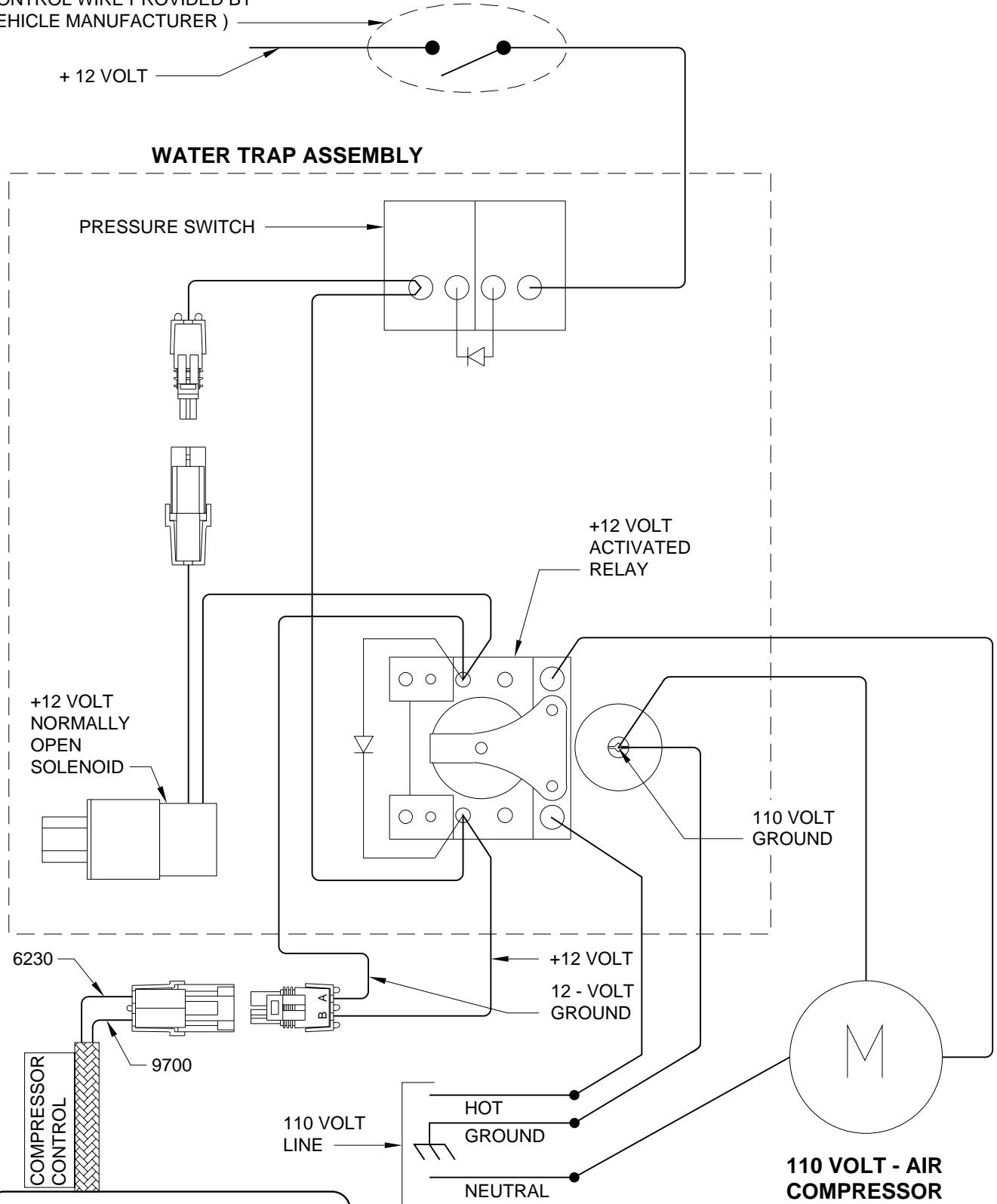

SEE ELECTRICAL CONNECTION DIAGRAM 680 SERIES CONNECTIONS AT CONTROL BOX POWER - WARNING INDICATORS - AIR LEVELING - HYDRAULIC MANIFOLD

# ELECTRICAL CONNECTION DIAGRAM

## AIR SEAL

### AIR SEAL WITH VACUUM MANIFOLD

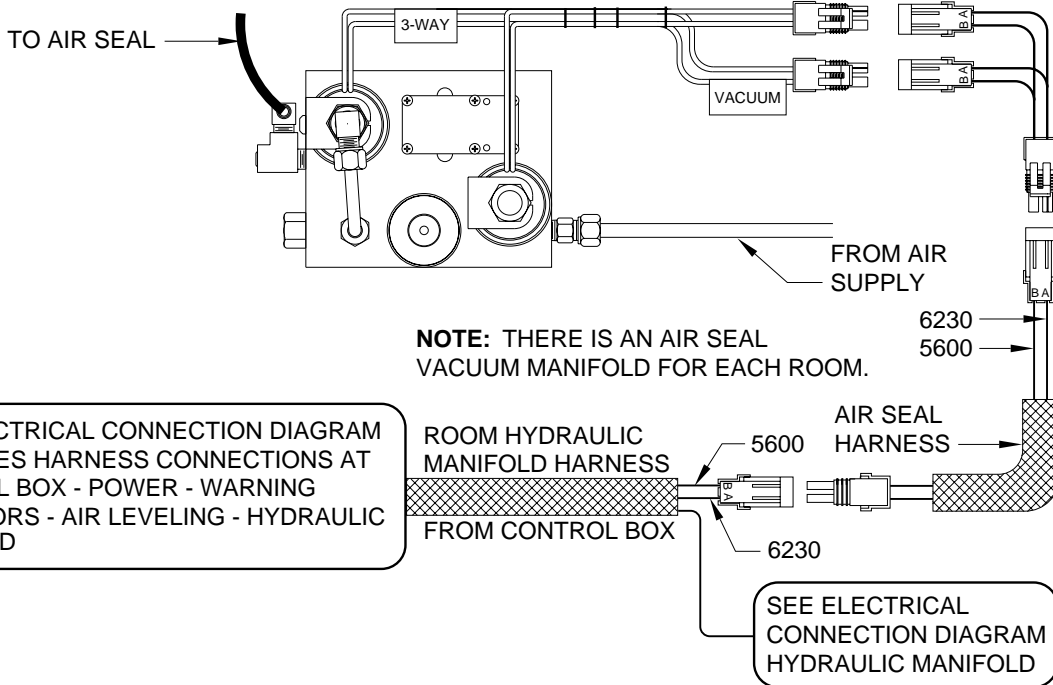

### AIR SEAL WITH AIR DUMP / REGULATOR ASSEMBLY

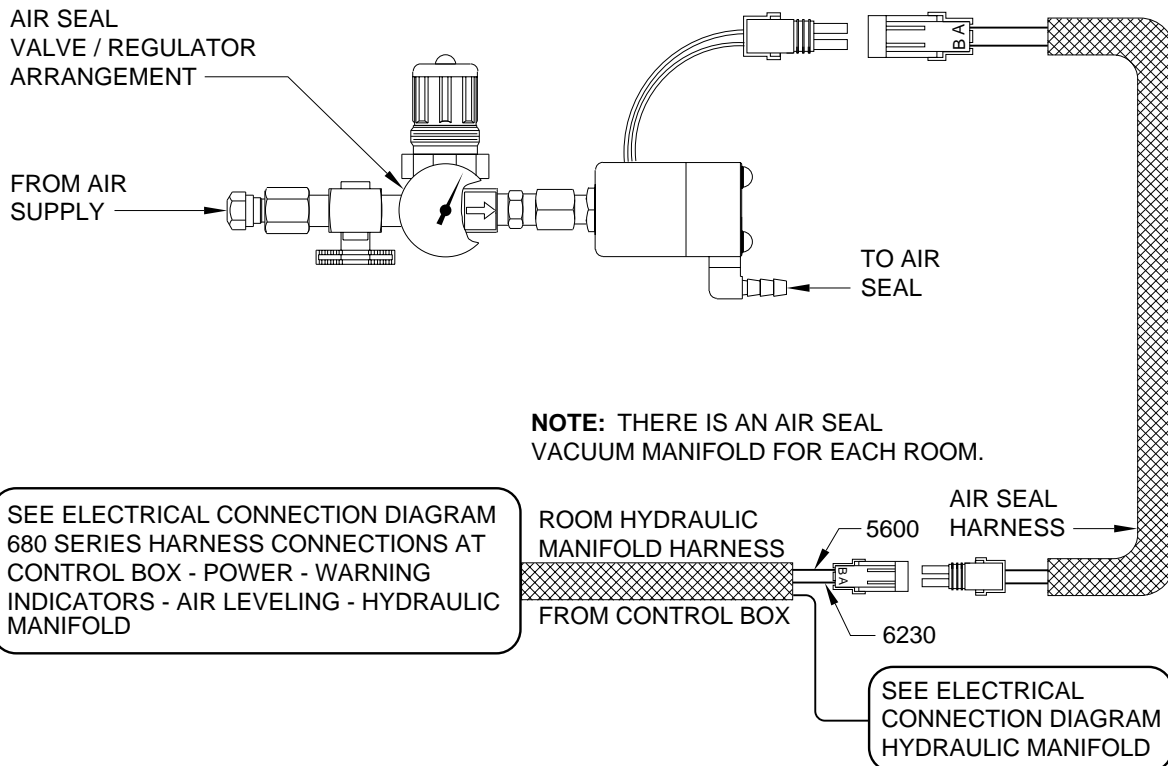

# ELECTRICAL CONNECTION DIAGRAM

## LIMIT SWITCH INDICATOR BOX

### LEVEL FLOOR ROOM EXTENSION

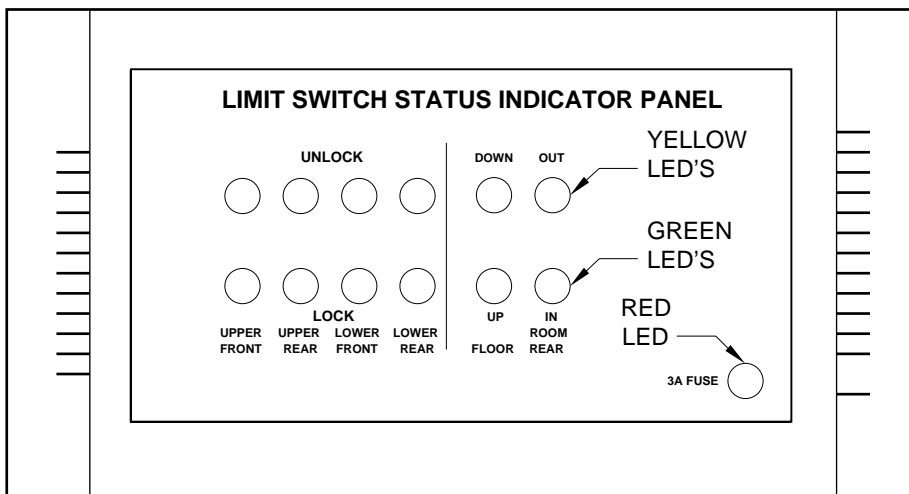

**NOTE:** THE LED'S WILL COME ON WHEN A LIMIT SWITCH IS MADE AND IGNITION SWITCH IS ON.

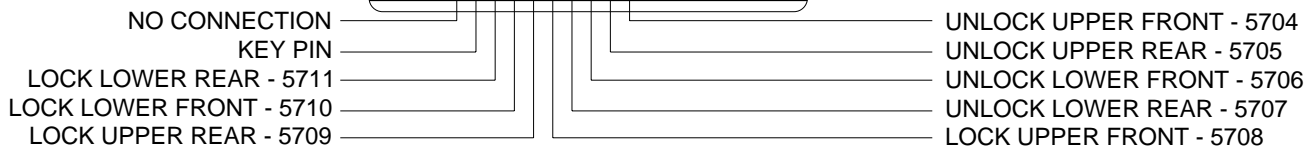
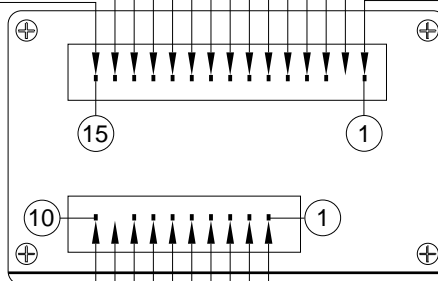
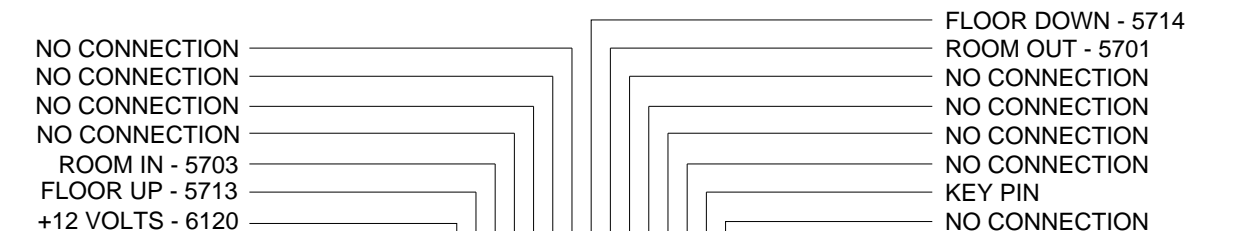
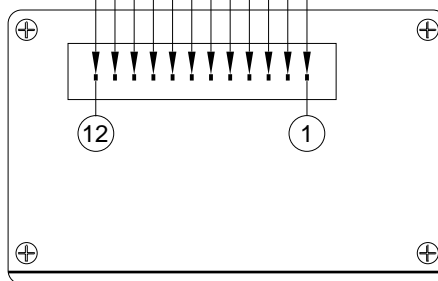
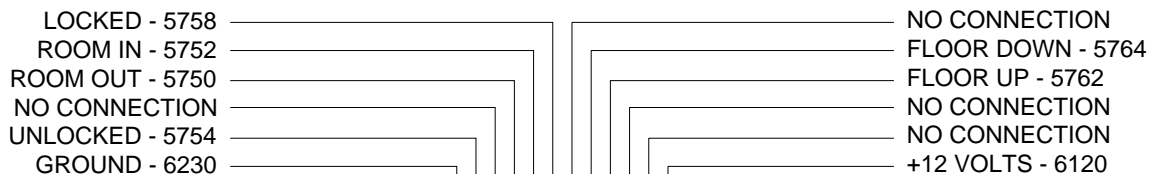

# ELECTRICAL CONNECTION DIAGRAM LEVEL FLOOR ROOM EXTENSION LIMIT SWITCHES

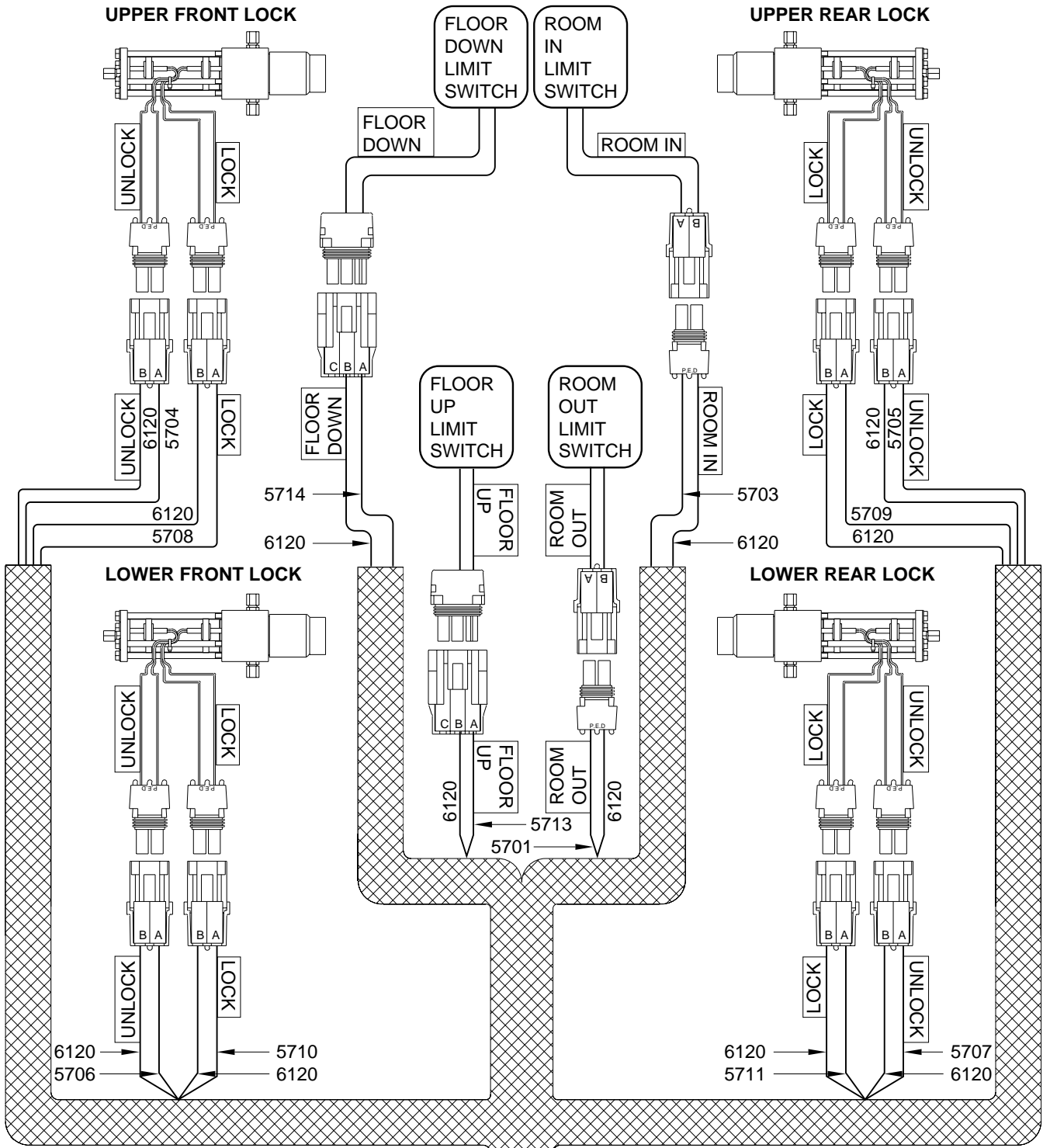

- (1) UPPER FRONT UNLOCK - 5704
- (2) UPPER REAR UNLOCK - 5705
- (3) LOWER FRONT UNLOCK - 5706
- (4) LOWER REAR UNLOCK - 5707
- (5) UPPER FRONT LOCK - 5708
- (6) UPPER REAR LOCK - 5709
- (7) LOWER FRONT LOCK - 5710
- (8) LOWER REAR LOCK - 5711

**SEE ELECTRICAL CONNECTION DIAGRAM  
LIMIT SWITCH INDICATOR BOX - LEVEL FLOOR  
ROOM EXTENSION**

- (15) +12 VOLTS - 6120
- (14) FLOOR UP - 5713
- (13) ROOM IN - 5703
- (8) FLOOR DOWN - 5714
- (7) ROOM OUT - 5701

# ELECTRICAL CONNECTION DIAGRAM

## LIMIT SWITCH INDICATOR BOX

### REAR ROOM EXTENSION

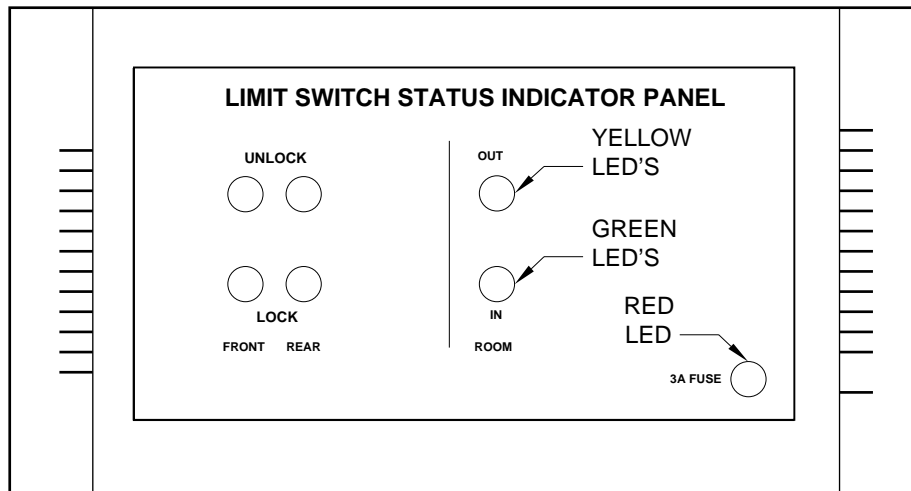

**NOTE:** THE LED'S WILL COME ON WHEN A LIMIT SWITCH IS MADE AND IGNITION SWITCH IS ON.

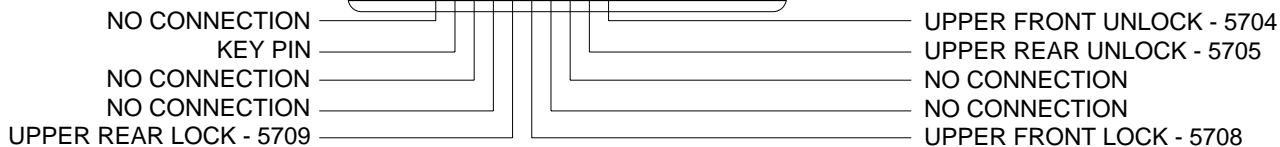
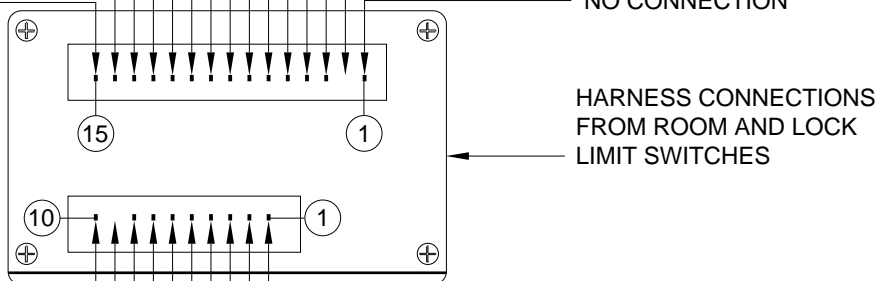
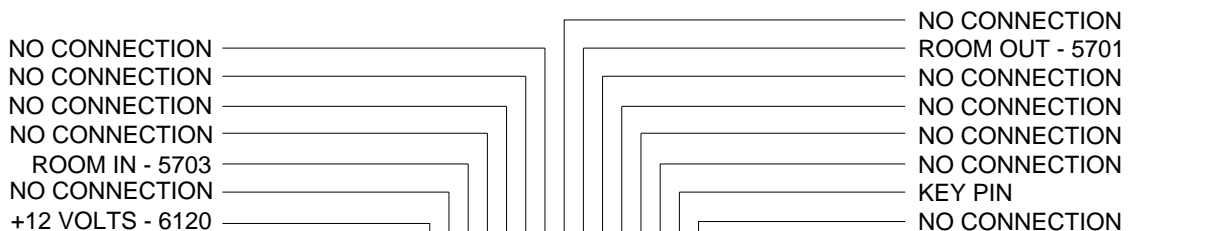
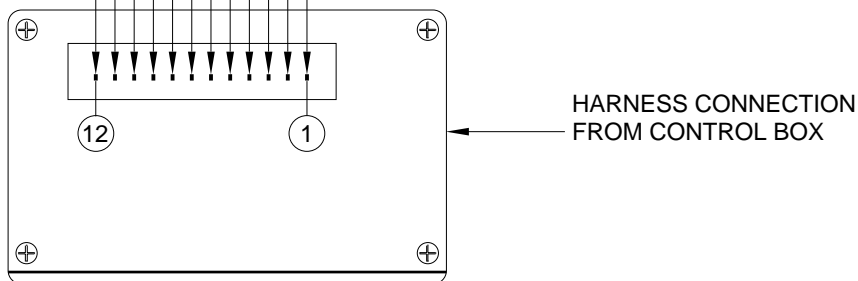
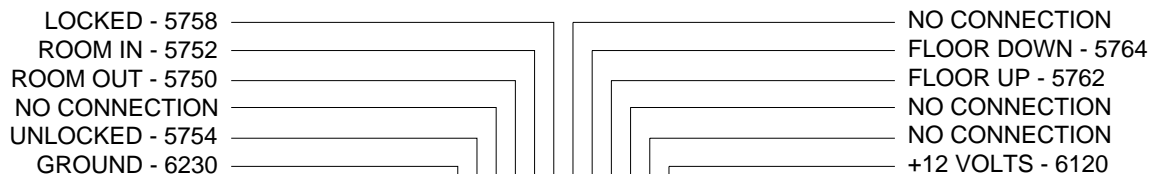

# ELECTRICAL CONNECTION DIAGRAM REAR ROOM EXTENSION LIMIT SWITCHES

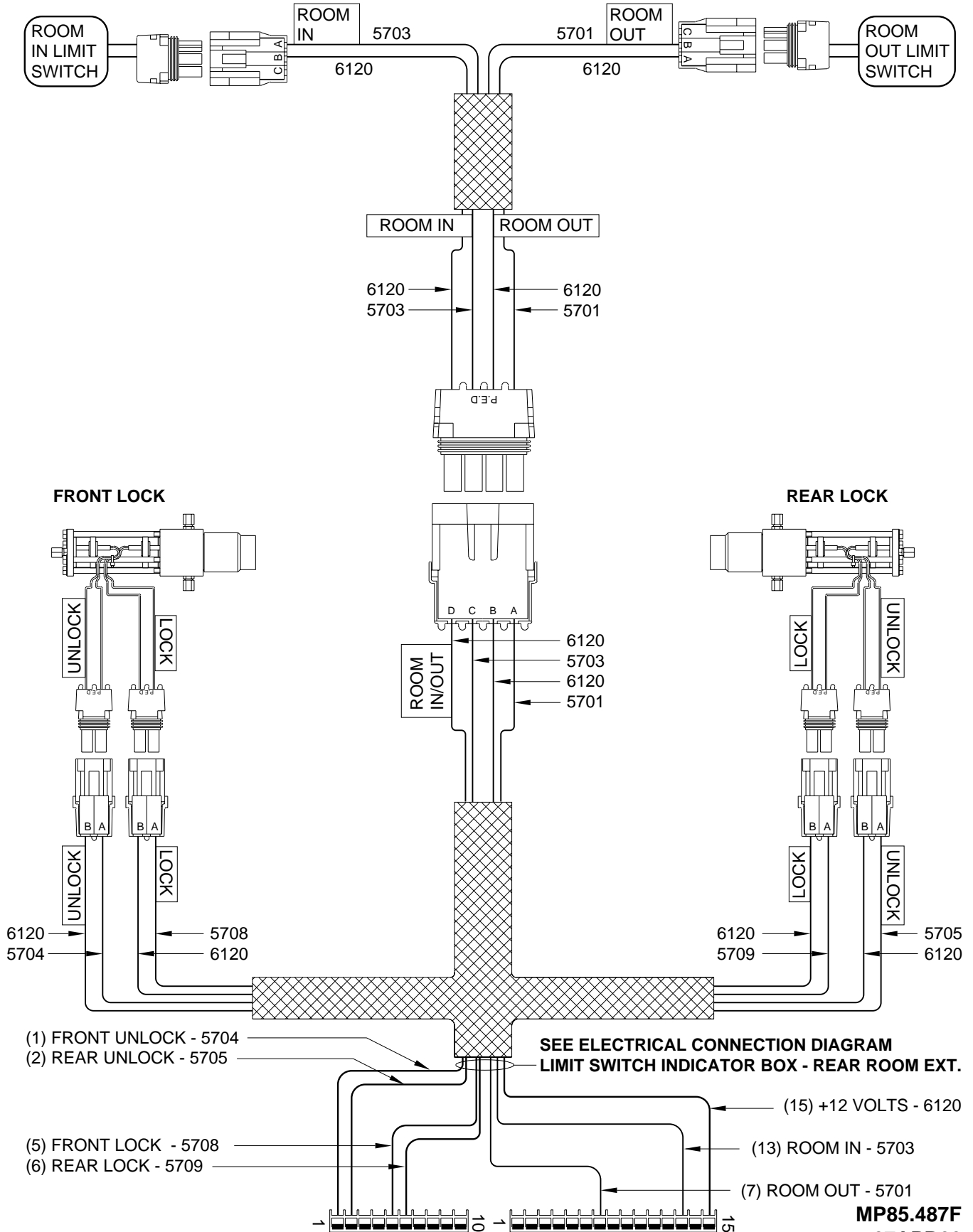





## BREATHER CAP - DIPSTICK - 1/4" NUT DRIVER

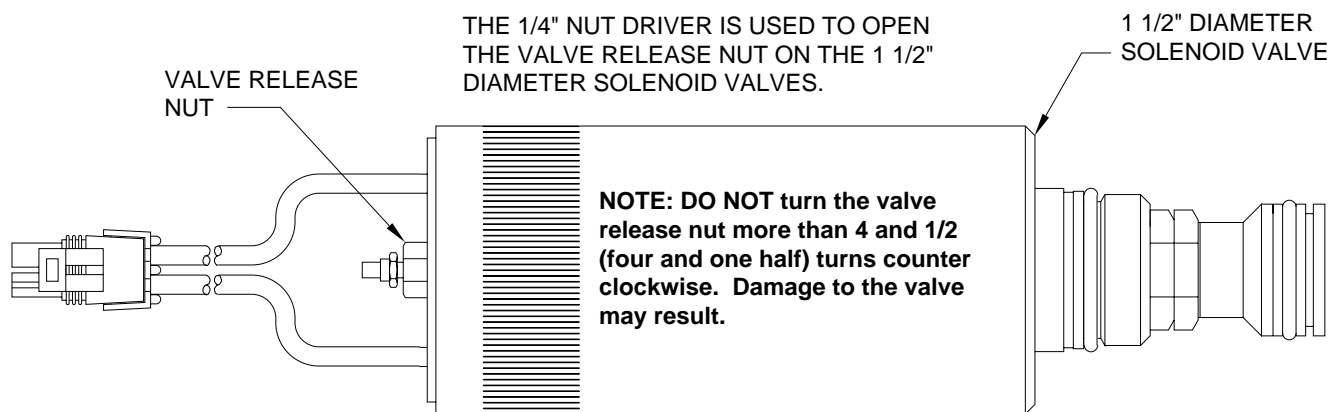

**NOTE: THE BREATHER CAP IS LOCATED ON THE TOP SIDE OF THE POWER UNIT RESERVOIR.**

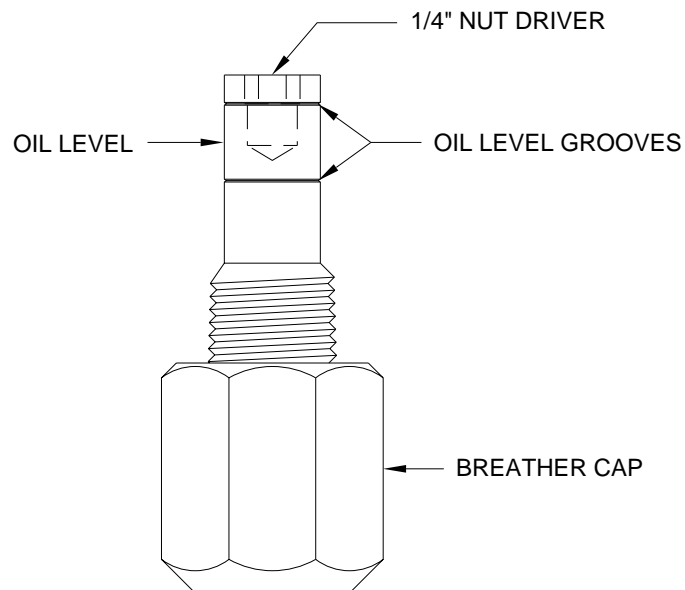

**IMPORTANT: PRIOR TO REMOVING THE BREATHER CAP, EITHER TO CHECK THE OIL LEVEL OR TO USE THE 1/4" NUT DRIVER, CLEAN ANY DEBRIS FROM THE TOP OF THE RESERVOIR. BEFORE RETURNING THE BREATHER CAP TO THE RESERVOIR, REMOVE ANY PAINT CHIPS OR OTHER DEBRIS FROM THE DIPSTICK INCLUDING DEBRIS INSIDE THE 1/4" NUT DRIVER.**